



Confetti maxtris[®]

CATALOGO EXPORT 2022



AZIENDA /COMPANY



*Confetti
maxtris*

For over a century the Italiana Confetti Srl strives to combine tradition and innovation, offering to the market a quality candy, made according to old craftsmanship and the most modern production technologies.

The love for the "arte confettiera" and the continuous search for improvement have enabled the company to achieve important goals promoting growth and development.



For almost a century serving our customers



With Dario and Nicola Prisco's guidance, the Italiana Confetti Srl has successfully made its name as one of the leading Italian confectionery industry, developing a daily production capacity of about 20.000 kg of confetti in the many different tastes and colours, specified in production.

During 2014 important investments were begun both for the expansion of the plant of approximately 3,000 m² covered (in addition to the existing 2,500 m²), and for the purchase of machineries of the last generation, projected and realized according to our needs. In the 2017 we added to our plant a new warehouse completely dedicated to the logistic service. Our company has been investing much in the field of communications and marketing with the continuous restyling of the packaging and choosing as brand testimonial Enzo Miccio, the most famous wedding planner in Italy.

Nicola and Dario Prisco, factory's owners. In the third picture, Dario Prisco and Enzo Miccio, a famous Italian wedding planner and television character, during a visit to the factory.

ECO FRIENDLY



The factory in Scisciano



A COMPANY TOTALLY ECO

Italiana Confetti has been always paying great attention to the problem of the respect of the environment and to the questions of its safeguard.

The environmental sustainability is a primary value for us, we have translated it in a concrete commitment. It has been always respected in all our activities of planning, production and logistics. It's important the total respect for our customers and for ourselves.



MANUFACTURING PROCESSES



The company has always had the goal to grow by focusing on the standardization of production processes with the help of technologically advanced machinery capable of ensuring compliance with the set quality standard.

Chocolate items are produced and stored in places with controlled temperature to ensure the product's stability and integrity in any season of the year.

To be completely independent, we invested much in the purchasing of a technologically advanced machinery, who prints the chocolate souls in different shapes (almond shape, heart, small heart, lens and small lens).



Inside the factory in Scisciano



LABORATORY AND QUALITY CONTROL



Our company pays particular attention to the conformity of raw materials and finished products.

Therefore, inside we have a section dedicated to the Quality Control, made up by three people, each one with different tasks and specific responsibilities, who daily work to satisfy our Customers' needs.

We have a laboratory inside, equipped to carry out the necessary verifications of hygienic-sanitary conformity of raw materials and finished products.

In addition to the internal laboratory, which is useful for preliminary and procedural checks, Italiana Confetti Srl uses external accredited laboratories to check the parameters of controls of food safety and hygiene of the process prescribed by the regulations for the sector. This organization provides every day over 100 quality checks on raw materials and finished products! The commitment of the Management and Quality Control Office has over the years rewarded the investment through the reduction of non-compliance and complaints by customers. In addition, the Company is currently certified BRC and IFS, being conform to the international standards for food safety.

STANDARDS



Italiana Confetti Srl, aware of the importance and the need to demonstrate and document its customers the ability to provide continuity with products that comply with the specifications and to meet their expectations, we thought it was necessary to implement a Management System for Quality and Food Safety in accordance with the requirements contained in the UNI EN ISO 9001:2008 and UNI EN ISO 22000:2005.

For Italiana Confetti making quality is first of all ensuring the food safety of their products. In fact, the last company's goal was to be found conform, in a short time, structurally and culturally to the most complex international standards imposed by the BRC / IFS.

The achievement of these purposes has been possible thanks to the creation of a new plant in which innovation and guarantees for food safety are the masters. To us it is important the selection of suppliers of raw materials that respect internal standards.

Finally, the continuous education and training of the staff must be considered as an other commitment and guarantees of quality that Italiana Confetti gives to its customers.

SACCHETTI MAXTRIS

150g pack
Counter display 12pcs.



**MAXTRIS GLI AGRUMI /
CITRUS FRUITS**
(GLUTEN FREE)
Toasted almond in white orange
and lemon flavored chocolate,
in a thin layer of sugar.

COD. U.V.	DESCRIZIONE	EAN cod. PZ EAN cod. U.V.
ESMAXAGR150	Espositore Sacchetto Maxtris Agrumi 150g x 12pz	8022470238914 8022470238921
U.M.	KG netti U.V.	Pz. x crt.
pz	1,8	12
Ct. x strato	Strati x pallet	Ct. x pallet
18	6	108

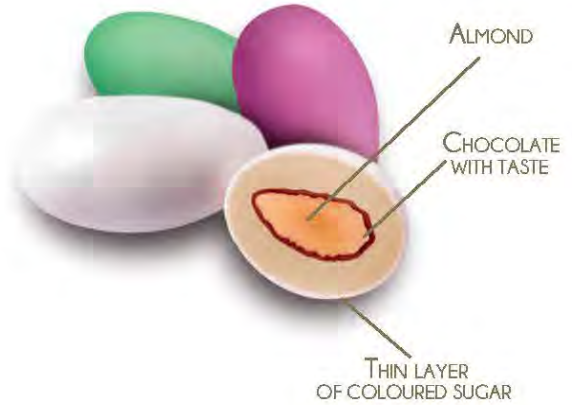

MAXTRIS MIX
(GLUTEN FREE)
Toasted almond in white choco-
late in mix flavors: (cherry, orange,
lemon, coconut, strawberry, green
apple, gold (milk chocolate), nut
(milk chocolate giandua), noir
(dark chocolate), classic (white
and dark chocolate) in a thin and
colored layer of sugar.

COD. U.V.	DESCRIZIONE	EAN cod. PZ EAN cod. U.V.
ESMAXMIX150	Espositore Sacchetto Maxtris Mix 150g x 12pz.	8022470230994 8022470232615
U.M.	KG netti U.V.	Pz. x crt.
pz	1,8	12
Ct. x strato	Strati x pallet	Ct. x pallet
18	6	108

Your color, your taste



MAXTRIS NUT
(GLUTEN FREE)
Toasted almond in milk chocolate
and milk giandua chocolate, in a
thin layer of sugar.

COD. U.V.	DESCRIZIONE	EAN cod. PZ EAN cod. U.V.
ESMAXNUT150	Espositore Sacchetto Maxtris Nut 150g x 12pz.	8022470231014 8022470232639
U.M.	KG netti U.V.	Pz. x crt.
pz	1,8	12
Ct. x strato	Strati x pallet	Ct. x pallet
18	6	108



**MAXTRIS PISTACCHIO /
PISTACHE**
(GLUTEN FREE)
Toasted almond in white pistachio
flavored chocolate, in a thin layer
of sugar.

COD. U.V.	DESCRIZIONE	EAN cod. PZ EAN cod. U.V.
ESMAXPIS150	Espositore Sacchetto Maxtris Pistacchio 150g x 12pz.	8022470231045 8022470232677
U.M.	KG netti U.V.	Pz. x crt.
pz	1,8	12
Ct. x strato	Strati x pallet	Ct. x pallet
18	6	108



MAXTRIS MARBLED
(GLUTEN FREE)
Toasted almond in white
chocolate in mix flavors (ricotta
cheese and pear, berries yogurt,
babà with cream, lemon delizia,
Sicilian cassata), in a thin and
colored layer of sugar.

COD. U.V.	DESCRIZIONE	EAN cod. PZ EAN cod. U.V.
ESMAXMUR150	Espositore Sacchetto Maxtris Marbled 150g x 12pz.	8022470231007 8022470232622
U.M.	KG netti U.V.	Pz. x crt.
pz	1,8	12
Ct. x strato	Strati x pallet	Ct. x pallet
18	6	108

Your color, your taste



SACCHETTI MAXTRIS

150g pack
Counter display 12 pcs.



**MAXTRIS CAFFÈ
ESPRESSO NAPOLETANO /
DARK COFFEE
(GLUTEN FREE)**
*Toasted almond in dark coffee
flavored chocolate in a thin layer of sugar.*

COD U.V.	DESCRIZIONE	EAN cod. PZ EAN cod.U.V.
ESMAXCAF150	Espositore Sacchetto Maxtris Caffè espresso 150g x 12pz.	8022470230970 8022470232585
U.M.	KG netti U.V.	Pz. x crt.
pz	1,8	12
Ct. x strato	Strati x pallet	Ct. x pallet
18	6	108



**MAXTRIS YOGURT
AI FRUTTI DI BOSCO /
YOGURT BERRIES
(GLUTEN FREE)**
*Toasted almond in white yogurt
berries flavored chocolate, in a
thin layer of sugar.*

COD U.V.	DESCRIZIONE	EAN cod. PZ EAN cod.U.V.
ESMAXYOG150	Espositore Sacchetto Maxtris Yogurt ai frutti di bosco 150g x 12pz.	8022470231021 8022470232653
U.M.	KG netti U.V.	Pz. x crt.
pz	1,8	12
Ct. x strato	Strati x pallet	Ct. x pallet
18	6	108

ESPOSITORI

Display



COUNTER DISPLAY 12 PCS
FACING 2 x 6 DEPTH
AVAILABLE FOR EACH ITEM

U.M.	KG netti U.V.	Pz. x crt.
pz	1,8	12
Ct. x strato	Strati x pallet	Ct. x pallet
18	6	108



FLOORSTAND 80 PCS
FACING 16x5 DEPTH

COD U.V.	DESCRIZIONE	EAN cod. U.V.
ESPSACMAX80	Espositore da Terra Confetti Maxtris in Sacchetti Assortiti 150g x 80 Pz	8022470238631
U.M.	KG netti U.V.	Pz. x pallet
pz	12	24



COUNTER DISPLAY 12 PCS
FACING 1 x 12 DEPTH
AVAILABLE FOR EACH ITEM

SACCHETTI DRAGEES

150g pack
Counter display 12pcs.



LE MANDORLE DARK CHOCOLATE ALMOND (GLUTEN FREE)

Toasted almond in dark chocolate



COD U.V.	DESCRIZIONE	EAN cod. PZ EAN cod. U.V.
ESPRAMANF150	Espositore praline Le mandorle al cioccolato fondente in sacchetto 150g x12pz	8022470238389 8022470238464
U.M.	KG netti U.V.	Pz. x crt.
pz	1,8	12
Ct. x strato	Strati x pallet	Ct. x pallet
18	6	108



LE MANDORLE MILK CHOCOLATE ALMOND (GLUTEN FREE)

Toasted almond in milk chocolate



COD U.V.	DESCRIZIONE	EAN cod. PZ EAN cod. U.V.
ESPRAMANL150	Espositore praline Le mandorle al cioccolato al latte in sacchetto 150g x12pz	8022470238396 8022470238471
U.M.	KG netti U.V.	Pz. x crt.
pz	1,8	12
Ct. x strato	Strati x pallet	Ct. x pallet
18	6	108



LE MANDORLE WHITE CHOCOLATE ALMOND (GLUTEN FREE)

Toasted almond in white chocolate



COD U.V.	DESCRIZIONE	EAN cod. PZ EAN cod. U.V.
ESPRAMANB150	Espositore praline Le mandorle al cioccolato bianco in sacchetto 150g x12pz	8022470238426 8022470238501
U.M.	KG netti U.V.	Pz. x crt.
pz	1,8	12
Ct. x strato	Strati x pallet	Ct. x pallet
18	6	108



IL CAFFÈ DARK CHOCOLATE COFFEE BEAN (GLUTEN FREE)

Coffee bean in dark chocolate



COD U.V.	DESCRIZIONE	EAN cod. PZ EAN cod. U.V.
ESPRACAFF150	Espositore praline Il caffè con cioccolato fondente in sacchetto 150g x12pz	8022470238433 8022470238518
U.M.	KG netti U.V.	Pz. x crt.
pz	1,8	12
Ct. x strato	Strati x pallet	Ct. x pallet
18	6	108



CEREAL CHOCO LATTE MILK CEREAL CHOCO (CONTAINS GLUTEN)

Crunchy cereals in milk chocolate



COD U.V.	DESCRIZIONE	EAN cod. PZ EAN cod. U.V.
ESPRACERL150	Espositore Praline Cereal Choco Latte Sacchetto 150g x12 Pz	8022470242638 8022470242645
U.M.	KG netti U.V.	Pz. x crt.
pz	1,8	12
Ct. x strato	Strati x pallet	Ct. x pallet
18	6	108

SACCHETTI DRAGEES

150g pack
Counter display 12pcs.



LE CILIEGE
DARK CHOCOLATE CHERRY
(GLUTEN FREE)
Cherry in dark chocolate



COD U.V.	DESCRIZIONE	EAN cod. PZ EAN cod. U.V.
ESPRACILF150	Espositore praline Le ciliege al cioccolato fondente in sacchetto 150g x12pz	8022470238365 8022470238440

U.M.	KG netti U.V.	Pz. x crt.
pz	1,8	12
Ct. x strato	Strati x pallet	Ct. x pallet
18	6	108



LE CILIEGE
MILK CHOCOLATE CHERRY
(GLUTEN FREE)
Cherry in milk chocolate



COD U.V.	DESCRIZIONE	EAN cod. PZ EAN cod. U.V.
ESPRACILL150	Espositore praline Le ciliege al cioccolato al latte in sacchetto 150g x12pz	8022470238372 8022470238457

U.M.	KG netti U.V.	Pz. x crt.
pz	1,8	12
Ct. x strato	Strati x pallet	Ct. x pallet
18	6	108



LE NOCCIOLE
DARK CHOCOLATE
HAZELNUT (GLUTEN FREE)
Toasted hazelnut in dark
chocolate



COD U.V.	DESCRIZIONE	EAN cod. PZ EAN cod. U.V.
ESPRANOCF150	Espositore praline Le nocchie al cioccolato fondente in sacchetto 150g x12pz	8022470238419 8022470238488

U.M.	KG netti U.V.	Pz. x crt.
pz	1,8	12
Ct. x strato	Strati x pallet	Ct. x pallet
18	6	108



LE NOCCIOLE
MILK CHOCOLATE
HAZELNUT (GLUTEN FREE)
Toasted hazelnut in milk
chocolate



COD U.V.	DESCRIZIONE	EAN cod. PZ EAN cod. U.V.
ESPRANOCL150	Espositore praline Le nocchie al cioccolato al latte in sacchetto 150g x12pz	8022470238402 8022470238495

U.M.	KG netti U.V.	Pz. x crt.
pz	1,8	12
Ct. x strato	Strati x pallet	Ct. x pallet
18	6	108



MINI AMARETTI FONDENTE
DARK CHOCOLATE MINI
Mini Amaretti in dark chocolate



COD U.V.	DESCRIZIONE	EAN cod. PZ EAN cod. U.V.
ESPPRAAMTF150	Espositore Praline Mini Amarettini al Cioccolato fondente Sacchetto 150g x12Pz	8022470242591 8022470242607

U.M.	KG netti U.V.	Pz. x crt.
pz	1,8	12
Ct. x strato	Strati x pallet	Ct. x pallet
18	6	108



MINI AMARETTI LATTE
MILK CHOCOLATE MINI
Mini Amaretti in milk chocolate



COD U.V.	DESCRIZIONE	EAN cod. PZ EAN cod. U.V.
ESPPRAAMTL150	Espositore Praline Mini Amarettini al Cioccolato Latte Sacchetto 150g x12Pz	8022470242614 8022470242621

U.M.	KG netti U.V.	Pz. x crt.
pz	1,8	12
Ct. x strato	Strati x pallet	Ct. x pallet
18	6	108

SACCHETTI DRAGEES

150g pack
Counter display 12pcs.



COUNTER DISPLAY 12 PCS-FACING 2x6 DEPTH
AVAILABLE FOR EACH ITEM

U.M.	KG netti U.V.	Pz. x crt.
pz	1,8	12
Ct. x strato	Strati x pallet	Ct. x pallet
18	6	108



FLOORSTAND 80 PCS
FACING 16x5 DEPTH

COD U.V.	DESCRIZIONE	EAN cod. U.V.
ESSACPRABO	Espositore da Terra ASSORTITO con Sacchetti Praline 150g x 80 Pz	8022470238624
U.M.	KG netti U.V.	Pz. x pallet
pz	12	24

SACCHETTI EDEN FRUITS

150g pack



EDEN FRUITS
CHOCO & ORANGE
(GLUTEN FREE)
Orange covered with
dark chocolate



COD U.V.	DESCRIZIONE	EAN cod. PZ EAN cod. U.V.
ESPCHOORA150	Espositore Praline CHOCO & ORANGE Sacchetto Eden Fruits 150gx12Pz	8022470242799 8022470242805
U.M.	KG netti U.V.	Pz. x crt.
pz	1,8	12
Ct. x strato	Strati x pallet	Ct. x pallet
18	6	108



COUNTER DISPLAY 12 Pcs
FACING 2x6 DEPTH

U.M.	KG netti U.V.	Pz. x crt.
pz	1,8	12
Ct. x strato	Strati x pallet	Ct. x pallet
18	6	108



FLOORSTAND 80PCS
FACING 16x5 DEPTH
24 PCS X PALLET



EDEN FRUITS
CHOCO & RAISINS
(GLUTEN FREE)
Raisins covered with
milk chocolate



COD U.V.	DESCRIZIONE	EAN cod. PZ EAN cod. U.V.
ESPCHORA150	Espositore Praline CHOCO & RAISINS Sacchetto Eden Fruits 150gx12Pz	8022470242836 8022470242843
U.M.	KG netti U.V.	Pz. x crt.
pz	1,8	12
Ct. x strato	Strati x pallet	Ct. x pallet
18	6	108

VESUVIOTTO Maxtris

CORNET 160g / Bag 500g



Vesuviotto Maxtris Classico

Cornet 160 g

Milk chocolate filled with milk and gianduia cream and grains toasted Giffoni hazelnuts
 COD. U.V. CRT: VMCLA160
 EAN CRT: 8022470254495
 EAN PZ: 8022470254501.



Vesuviotto Maxtris Albicocca del Vesuvio – Cornet 160 g

White chocolate filled with lemon flavored cream.
 COD. U.V. CRT: VMCF70160
 EAN CRT: 8022470254518
 EAN PZ: 8022470254525



Vesuviotto Maxtris Limone

Cornet 160 g

Extra dark chocolate filled with dark cream.
 COD. U.V. CRT: VMCF70160
 EAN CRT: 8022470254518
 EAN PZ: 8022470254525



Vesuviotto Maxtris Fondente 70% – Cornet 160 g

Dark chocolate filled with white cream apricots flavored.
 COD. U.V. CRT: VMCALB160
 EAN CRT: 8022470254556
 EAN PZ: 8022470254563

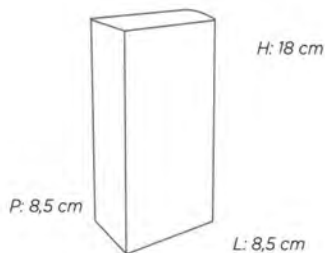

SCHEDA TECNICA PER SUPPORTO VENDITA

PESO PZ.: 160 g
 PZ. PER CRT.: 12
 DIMENSIONI CRT.: L 39,5 cm x H 22 cm x P 26,5 cm

CARTONI X STRATO	STRATI X PALLET	H.PALLET
9	7	144 cm

Espositore Vesuviotto Maxtris Cornet 60 pz

Floorstand of Vesuviotto Maxtris in cornet pack, 60 pieces.

COD.U.V.: VMCESP160
 EAN: 8022470254808

VESUVIOTTO Maxtris

CORNET 160g / Bag 500g



Vesuviotto Maxtris Classico Bag 500 g

COD. U.V. CRT: VMBCLA500 EAN CRT: 8022470254570
EAN PZ: 8022470254587



Vesuviotto Maxtris Fondente 70% Bag 500 g

COD. U.V. CRT: VMBF70500 EAN CRT: 8022470254594
EAN PZ: 8022470254600



Vesuviotto Maxtris Limone Bag 500 g

COD. U.V. CRT: VMBLIM500 EAN CRT: 8022470254617
EAN PZ: 8022470254624



Vesuviotto Maxtris Albicocca del Vesuvio - Bag 500 g

COD. U.V. CRT: VMBALB500 EAN CRT: 8022470254631
EAN PZ: 8022470254648



H: 29 cm

SCHEDA TECNICA PER SUPPORTO VENDITA

PESO PZ.: 500 g
PZ. PER CRT.: 8
DIMENSIONI CRT.: L 39,5 cm x H 22 cm x P 26,5 cm

CARTONI X STRATO	STRATI X PALLET	H.PALLET
9	7	144 cm



Vesuviotto Maxtris Sfuso 1 Kg

Confezione da 1 Kg con etichetta

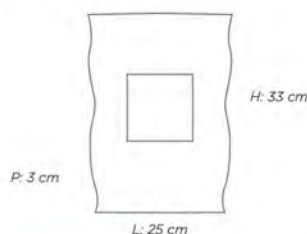

SCHEDA TECNICA PER SUPPORTO VENDITA

PESO PZ.: 1 Kg
PZ. PER CRT.: 4
DIMENSIONI CRT.: L 39,5 cm x H 22 cm x P 26,5 cm

CARTONI X STRATO	STRATI X PALLET	H.PALLET
9	7	144 cm



Vesuviotto Maxtris Classico Sfuso 1 Kg

COD. U.V. CRT: VMSCLA
EAN CRT: 8022470254655
EAN PZ: 8022470254662

Vesuviotto Maxtris Fondente 70% Sfuso 1 Kg

COD. U.V. CRT: VMSP70
EAN CRT: 8022470254679
EAN PZ: 8022470254686

Vesuviotto Maxtris Limone della Costiera - Sfuso 1 Kg

COD. U.V. CRT: VMSLIM
EAN CRT: 8022470254693
EAN PZ: 8022470254709

Vesuviotto Maxtris Albicocca del Vesuvio - Sfuso 1 Kg

COD. U.V. CRT: VMSALB
EAN CRT: 8022470254716
EAN PZ: 8022470254723

MAXTRIS MOON



**MAXTRIS MOON
LATTE STABILO 165 G**
Ball with milk chocolate filled with a
milk chocolate cream.



**MAXTRIS MOON
FONDENTE 70% STABILO 165 G**
Ball with a shell of extra dark chocolate
and filled with a extra dark chocolate cream.



**MAXTRIS MOON
PISTACCHIO STABILO 165 G**
Ball with milk chocolate filled
with white cream pistachio flavored.



**MAXTRIS MOON
NOCCIOLATO STABILO 165 G**
Ball with dark chocolate filled
with dark chocolate cream
and whole 100% italian hazelnut.

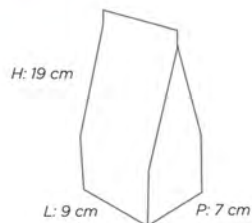

Espositore Vesuviotto
Maxtris Comet 80 pz
Floorstand of Maxtris Moon
in stabilopack, 80 pieces.

SCHEDA TECNICA PER SUPPORTO VENDITA

PESO PZ.: 165 g
PZ. PER CRT.: 15
DIMENSIONI CRT.: L 39,5 cm x H 22 cm x P 26,5 cm

CARTONI X STRATO	STRATI X PALLET	H.PALLET
9	7	144 cm



MAXTRIS MOON



Maxtris Moon Latte
Ball with milk chocolate filled
with a milk chocolate cream.
COD. U.V. CRT: MMBLAT500
EAN CRT: 8022470254938
EAN PZ: 8022470254891



Maxtris Moon Fondente
70% (cacao min)
Ball with a shell of extra dark chocolate
and filled with a extra dark chocolate cream.
COD. U.V. CRT: MMBF70500
EAN CRT: 8022470254945
EAN PZ: 8022470254907



Maxtris Moon Nocciolato
Ball with dark chocolate filled with
dark chocolate cream and whole
100% italian hazelnut.
COD. U.V. CRT: MMBNOC500
EAN CRT: 8022470254969
EAN PZ: 8022470254921



Maxtris Moon Pistacchio
Ball with milk chocolate filled
with white cream pistachio flavored.
COD. U.V. CRT: MMBPIS500
EAN CRT: 8022470254952
EAN PZ: 8022470254914

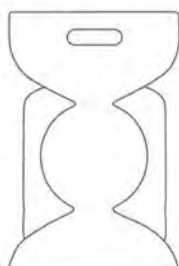

H: 29 cm

P: 5 cm

L: 23 cm

SCHEDA TECNICA PER SUPPORTO VENDITA

PESO PZ.: 500 g
PZ. PER CRT.: 8
DIMENSIONI CRT.: L 39,5 cm x H 22 cm x P 26,5 cm

CARTONI X STRATO	STRATI X PALLET	H.PALLET
9	7	144 cm



Maxtris Moon Sfuso 1 Kg

Confezione da 1 Kg con etichetta

Maxtris Moon Latte Sfuso 1 Kg

COD. U.V. CRT: MMSLAT
EAN CRT: 8022470255010
EAN PZ: 8022470254976

Maxtris Moon Pistacchio Sfuso 1 Kg

COD. U.V. CRT: MMSPI5
EAN CRT: 8022470255034
EAN PZ: 8022470254990

Maxtris Moon 70% F Sfuso 1 Kg

COD. U.V. CRT: MMSF70
EAN CRT: 8022470255027
EAN PZ: 8022470254983

Maxtris Moon Nocciolato Sfuso 1 Kg

COD. U.V. CRT: MMSNOC
EAN CRT: 8022470255041
EAN PZ: 8022470255003

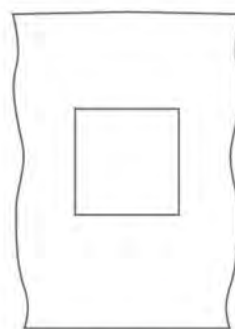

H: 33 cm

P: 3 cm

L: 25 cm

SCHEDA TECNICA PER SUPPORTO VENDITA

PESO PZ.: 1 Kg
PZ. PER CRT.: 4
DIMENSIONI CRT.: L 39,5 cm x H 22 cm x P 26,5 cm

CARTONI X STRATO	STRATI X PALLET	H.PALLET
9	7	144 cm



MAXTRIS TAB



Maxtris TAB Latte
Tavoletta 100 g

Tavoletta con finissimo cioccolato al latte.

Fine milk chocolate bar.

COD. U.V. CRT: 7M4700
EAN CRT: 802247025506
EAN FT: 802247025540



Maxtris TAB Nocciolato Latte - Tavoletta 100 g

Tavoletta con Cioccolato al latte e nocchie intere 100% italiane.

Milk chocolate bar with whole 100% Italian hazelnuts.

COD. U.V. CRT: 7M47NOC100
EAN CRT: 802247025507
EAN FT: 802247025537



Maxtris TAB Mandorlato Bianco - Tavoletta 100 g

Tavoletta con cioccolato bianco e mandorle intere tostate.

White chocolate bar with toasted almonds.

COD. U.V. CRT: 7M81AMAND100
EAN CRT: 802247025508
EAN FT: 802247025564



Maxtris TAB Crunch
Tavoletta 100 g

Tavoletta con cioccolato al latte e mini-lettini al cioccolato.

Milk chocolate bar with chocolate mini-horns.

COD. U.V. CRT: 7MCRU100
EAN CRT: 802247025509
EAN FT: 802247025571



Maxtris TAB Mandorlato
Tavoletta 100 g

Tavoletta con cioccolato fondente e mandorle intere tostate.

Extra-dark chocolate bar with toasted almonds.

COD. U.V. CRT: 7M81MAND100
EAN CRT: 802247025508
EAN FT: 802247025564



Maxtris TAB Nocciolato Fondente - Tavoletta 100 g

Tavoletta con cioccolato fondente e nocchie intere 100% italiane.

Extra-dark chocolate with whole 100% Italian hazelnuts.

COD. U.V. CRT: 7M81NOC100
EAN CRT: 802247025508
EAN FT: 802247025564



Maxtris TAB Fondente 70%
Tavoletta 100 g

Tavoletta con irresistibile cioccolato extra-fondente.

Irresistibile extra-dark chocolate bar.

COD. U.V. CRT: 7M70100
EAN CRT: 802247025502
EAN FT: 802247025588



Maxtris TAB Fondente 85%
Tavoletta 100 g

Tavoletta con cioccolato extra-fondente deciso e intenso.

Strong and intense extra-dark chocolate bar.

COD. U.V. CRT: 7M85100
EAN CRT: 802247025509
EAN FT: 802247025595

U.V. Maxtris TAB 100g

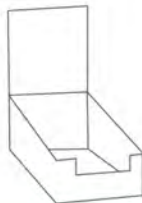

SCHEDA TECNICA PER SUPPORTO VENDITA

PESO PZ:	100 g
PZ. PER RIC:	12
PZ. PER CRT:	12
DIMENSIONI CRT:	L 39,5 cm x H 22 cm x P 26,5 cm

CARTONI X STRATO	STRATI X PALLET	H.PALLET
9	7	144 cm



Espositore Maxtris TAB
64 pz

Espositore da banco di Maxtris TAB convertibile da terra di tavolette, da 64 pezzi.

Counter display available also in floorstand mode of Maxtris TAB, 64 pieces.

COD. U.V. CRT: 7MESPI00
EAN FT: 802247025546



Ricariche

Da 12 pezzi.
From 12 pieces.

TASK

30g pack



TASK ALMOND
(GLUTEN FREE)

Toasted almond in extra dark chocolate (min. cocoa 70%).

COD U.V.	EAN cod. PZ	EAN cod. U.V.
TASKMAN30	8022470250114	8022470250244

U.M.	KG netti U.V.	Pz. x crt.
pz	0,03	32
Ct. x strato	Strati x pallet	Ct. x pallet
16	16	256



TASK WALNUTS
(GLUTEN FREE)

Walnuts in extra dark chocolate (min. cocoa 70%).

COD U.V.	EAN cod. PZ	EAN cod. U.V.
TASKNOCE30	8022470250121	8022470250237

U.M.	KG netti U.V.	Pz. x crt.
pz	0,03	32
Ct. x strato	Strati x pallet	Ct. x pallet
16	16	256



TASK CASHEW
(GLUTEN FREE)

Toasted Cashew in extra dark chocolate (min. cocoa 70%).

COD U.V.	EAN cod. PZ	EAN cod. U.V.
TASKANAE3070	8022470252972	8022470253085

U.M.	KG netti U.V.	Pz. x crt.
pz	0,03	32
Ct. x strato	Strati x pallet	Ct. x pallet
16	16	256



AVAILABLE WITH EUROHOLE



COUNTER DISPLAY TASK
(3 x 9 = 27 Pcs)

COD U.V.	EAN cod. U.V.
ETK27	8022470253030

U.M.	KG netti U.V.	Pz. x crt.
pz	0,03	3x9=27
Ct. x strato	Strati x pallet	Ct. x pallet
23	11	253

NUTS & CHOCO

125g doypack



DOYPACK NUTS AND CHOCO

MixMax

Toasted cashew in dark chocolate, toasted peanut in milk chocolate and toasted hazelnut in white chocolate.

COD. PZ	EAN cod. PZ
COD. U.V.	EAN cod. U.V.
SDOYNCMIX125	8022470252163
DOYNCMIX125	8022470252378

U.M.	KG netti U.V.	Pz. x crt.
pz	0,125	6
Ct. x strato	Strati x pallet	Ct. x pallet
25	11	275

CARTON DISPLAY



H: 15,5 cm

D: 30 cm

W: 12,5 cm



DOYPACK NUTS AND CHOCO

MixMax

Sicilian orange in dark chocolate, toasted almond in white chocolate and peanut in milk chocolate.

COD. PZ	EAN cod. PZ
COD. U.V.	EAN cod. U.V.
SDOYNCMIX125	8022470252187
DOYNCMIX125	8022470252385

U.M.	KG netti U.V.	Pz. x crt.
pz	0,125	6
Ct. x strato	Strati x pallet	Ct. x pallet
25	11	275



DOYPACK NUTS AND CHOCO

EXTRADARK

Pecan nut, raisins and toasted almond in dark chocolate.

COD. PZ	EAN cod. PZ
COD. U.V.	EAN cod. U.V.
SDOYNC125	8022470252170
DOYNC125	8022470252361

U.M.	KG netti U.V.	Pz. x crt.
pz	0,125	6
Ct. x strato	Strati x pallet	Ct. x pallet
25	11	275



PESO: 125G



L: 13 cm

H: 17 cm

SHELL NUTS BENEFITS

GLUTEN FREE

PALM OIL FREE

FLOORSTAND

DOYPACK NUTS AND CHOCO

Dried fruits mixed covered with chocolate.

COD. PZ	EAN cod. PZ
COD. U.V.	EAN cod. U.V.
EDOYNC120	8022470252569

U.M.	KG netti U.V.	Pz. x crt.
pz	0,125	120
Ct. x strato	Strati x pallet	Ct. x pallet
6	1	6

HEXAGON TWIST

220g pack



ESAGONO TWIST – NOUGAT LATTE
(GLUTEN FREE)

Crunchy hazelnut in milk chocolate

COD. U.V.	EAN cod. PZ	EAN cod. U.V.
TBOXNOUGL220	8022470246636	8022470249019

U.M.	KG netti U.V.	Pz. x crt.
pz	0,22	8
Ct. x strato	Strati x pallet	Ct. x pallet
9	6	54



ESAGONO TWIST – NOUGAT FONDENTE
(GLUTEN FREE)

Crunchy hazelnut in dark chocolate

COD. U.V.	EAN cod. PZ	EAN cod. U.V.
TBOXNOUGF220	8022470246643	8022470249033

U.M.	KG netti U.V.	Pz. x crt.
pz	0,22	8
Ct. x strato	Strati x pallet	Ct. x pallet
9	6	54



ESAGONO TWIST – NOCCIOLA LATTE
(GLUTEN FREE)

Toasted hazelnut in milk chocolate

COD. U.V.	EAN cod. PZ	EAN cod. U.V.
TBOXNOCL220	8022470247350	8022470249040

U.M.	KG netti U.V.	Pz. x crt.
pz	0,22	8
Ct. x strato	Strati x pallet	Ct. x pallet
9	6	54



ESAGONO TWIST – MANDORLA FONDENTE
(GLUTEN FREE)

Toasted almond in dark chocolate

OD. U.V.	EAN cod. PZ	EAN cod. U.V.
TBOXMANF220	8022470246629	8022470249026

U.M.	KG netti U.V.	Pz. x crt.
pz	0,22	8
Ct. x strato	Strati x pallet	Ct. x pallet
9	6	54



TRUFFLE BAG

165g pack



TRUFFLE BAG
NOUGAT DARK
White chocolate bar with
toasted almonds.



TRUFFLE BAG
HAZELNUT & MILK
Toasted hazelnut in milk chocolate
and dusted with cocoa powder.



TRUFFLE BAG
DARK ALMOND
Toasted almond in dark chocolate
and dusted in cocoa powder.



TRUFFLE BAG
DARK CHERRIES
Candied cherry in dark chocolate
and dusted with cocoa powder.

SCHEDA TECNICA PER SUPPORTO VENDITA

PESO PZ:	165g
PZ. PER CRT:	8
DIMENSIONI CRT:	L 40 cm x H 18 cm x P 26,5 cm

TWIST

500g pack



CADEAUX TWIST BIANCO WHITE TWIST CADEAUX 500g (GLUTEN FREE)

Toasted almond in dark and white chocolate in a thin layer of sugar

COD U.V.	EAN cod. PZ EAN cod. U.V.
TWCADMAXB	8022470248074 8022470251180

U.M.	KG netti U.V.	Pz. x crt.
pz	0,5	8
Ct. x strato	Strati x pallet	Ct. x pallet
6	6	36



CADEAUX TWIST AZZURRO LIGHT BLUE TWIST CADEAUX 500g (GLUTEN FREE)

Toasted almond in dark and white chocolate in a thin layer of sugar

COD U.V.	EAN cod. PZ EAN cod. U.V.
TWCADMAXC	8022470248128 8022470251197

U.M.	KG netti U.V.	Pz. x crt.
pz	0,5	8
Ct. x strato	Strati x pallet	Ct. x pallet
6	6	36



CADEAUX TWIST ROSA PINK TWIST CADEAUX 500g (GLUTEN FREE)

Toasted almond in dark and white chocolate in a thin layer of sugar

COD U.V.	EAN cod. PZ EAN cod. U.V.
TWCADMAXR	8022470248098 8022470251203

U.M.	KG netti U.V.	Pz. x crt.
pz	0,5	8
Ct. x strato	Strati x pallet	Ct. x pallet
6	6	36



CADEAUX TWIST ROSSO RED TWIST CADEAUX 500g (GLUTEN FREE)

Toasted almond in dark and white chocolate in a thin layer of sugar

COD U.V.	EAN cod. PZ EAN cod. U.V.
TWCADMAXRS	8022470248111 8022470251210

U.M.	KG netti U.V.	Pz. x crt.
pz	0,5	8
Ct. x strato	Strati x pallet	Ct. x pallet
6	6	36



CADEAUX TWIST BIANCO HAZELNUT WHITE TWIST CADEAUX 500g (GLUTEN FREE)

Toasted hazelnut in dark and white chocolate in a thin layer of sugar

COD U.V.	EAN cod. PZ EAN cod. U.V.
TWCADNOIB	8022470248135 8022470251227

U.M.	KG netti U.V.	Pz. x crt.
pz	0,5	8
Ct. x strato	Strati x pallet	Ct. x pallet
6	6	36



CADEAUX TWIST AZZURRO HAZELNUT LIGHT BLUE TWIST CADEAUX 500g (GLUTEN FREE)

Toasted hazelnut in dark and white chocolate in a thin layer of sugar

COD U.V.	EAN cod. PZ EAN cod. U.V.
TWCADNONC	8022470248173 8022470251234

U.M.	KG netti U.V.	Pz. x crt.
pz	0,5	8
Ct. x strato	Strati x pallet	Ct. x pallet
6	6	36



CADEAUX TWIST ROSA HAZELNUT PINK TWIST CADEAUX 500g (GLUTEN FREE)

Toasted hazelnut in dark and white chocolate in a thin layer of sugar

COD U.V.	EAN cod. PZ EAN cod. U.V.
TWCADNOIR	8022470248142 8022470251241

U.M.	KG netti U.V.	Pz. x crt.
pz	0,5	8
Ct. x strato	Strati x pallet	Ct. x pallet
6	6	36



CADEAUX TWIST ROSSO HAZELNUT RED TWIST CADEAUX 500g (GLUTEN FREE)

Toasted hazelnut in dark and white chocolate in a thin layer of sugar

COD U.V.	EAN cod. PZ EAN cod. U.V.
TWCADNOIRS	8022470248166 8022470251258

U.M.	KG netti U.V.	Pz. x crt.
pz	0,5	8
Ct. x strato	Strati x pallet	Ct. x pallet
6	6	36

TRUFFLE TRAY

500g pack / Single Wrapped

**SINGLE
WRAPPED
INSIDE**



TARTUFINI CILIEGIE (GLUTEN FREE)
Candied cherries in dark chocolate, dusted with cocoa powder



TARTUFINI NOCCIOLA (GLUTEN FREE)
Hazelnuts in dark chocolate, dusted with cocoa powder.



TARTUFINI MANDORLE (GLUTEN FREE)
Almonds in dark chocolate and dusted with cocoa powder



TARTUFINI GIANDUIA (GLUTEN FREE)
Almonds in milk gianduja chocolate, dusted with cocoa powder.



tartufini

COD U.V.	DESCRIZIONE	EAN cod. U.V.
ESPITAR20	Espositore da Terra Assortito con Vassoi TARTUFINI 500 x 20 Pz	8022470238938
U.M.	KG netti U.V.	
pz	10	

FLOORSTAND 20 PCS
FACING 10 x 2 DEPTH



TARTUFINI TIRAMISÙ (GLUTEN FREE)
Almonds in white tiramisù flavored chocolate, dusted with cocoa powder.

VASSOI MAXTRIS SFUMATI

500g pack / Single wrapped



DOLCE ARRIVO MAXTRIS SFUMATI ROSA (GLUTEN FREE)

Toasted almond in white chocolate in mix flavours: coconut, Sicilian cannola, tiramisu, lemon delizia, covered by a thin layer of sugar, in different nuances of blue.

Your color, your taste



COCONO



SELAN CANNOLO



TIRAMISÙ



LEMON DELIZIA



DOLCE ARRIVO MAXTRIS SFUMATI ROSA (GLUTEN FREE)

Toasted almond in white chocolate in mix flavours: strawberry, sour cherry, blueberry, cheesecake, covered by a thin layer of sugar, in different nuances of pink.

Your color, your taste



STRAWBERRY



BAKED CHERRY



BLUEBERRY



CHEESECAKE



VASSOI MAXTRIS

500g pack / Single wrapped



DOLCE MIX MAXTRIS (GLUTEN FREE)

Toasted almond in white chocolate in mix flavors: (cherry, orange, lemon, coconut, strawberry, green apple, gold (milk chocolate), nut (milk chocolate gianduja), noir (dark chocolate), classic (white and dark chocolate) in a thin and colored layer of sugar.



Your color, your taste



CLASSIC



COCONO



NU



STRAWBERRY



NOIR



MILK



BAKED CHERRY



ORANGE



GREEN APPLE

VASSOI MAXTRIS

500g pack / Single wrapped



DOLCE EVENTO MAXTRIS (GLUTEN FREE)
Toasted almond in white and dark chocolate, in a thin layer of white sugar.



DOLCE EVENTO MIX FRUTTA BIANCO (GLUTEN FREE)
Toasted almond in white mix fruit flavored chocolate, (orange, strawberry, pistachio, berries and lemon), in a thin layer of sugar.



DOLCE ARRIVO MAXTRIS ROSA (GLUTEN FREE)
Toasted almond in white and dark chocolate, in a thin layer of pink sugar.



DOLCE ARRIVO MIX FRUTTA ROSA (GLUTEN FREE)
Toasted almond in white mix fruit flavored chocolate, (orange, strawberry, pistachio, berries and lemon), in a thin layer of pink sugar.



DOLCE ARRIVO MAXTRIS CELESTE (GLUTEN FREE)
Toasted almond in white and dark chocolate, in a thin layer of light blue sugar.



DOLCE ARRIVO MIX FRUTTA CELESTE (GLUTEN FREE)
Toasted almond in white mix fruit flavored chocolate, (orange, strawberry, pistachio, berries and lemon), in a thin layer of light blue sugar.



DOLCE LAUREA MAXTRIS (GLUTEN FREE)
Toasted almond in white and dark chocolate, in a thin layer of light blue sugar.



DOLCE LAUREA MIX FRUTTA (GLUTEN FREE)
Toasted almond in white mix fruit flavored chocolate, (orange, strawberry, pistachio, berries and lemon), in a thin layer of red sugar.



DOLCE LAUREA MAXTRIS (GLUTEN FREE)
Toasted almond in white and dark chocolate, in a thin layer of light blue sugar.



ORANGE



STRAWBERRY



PISTACHIO



YOGURT RED FRUITS



LEMON

COUNTER DISPLAY

Counter Displays

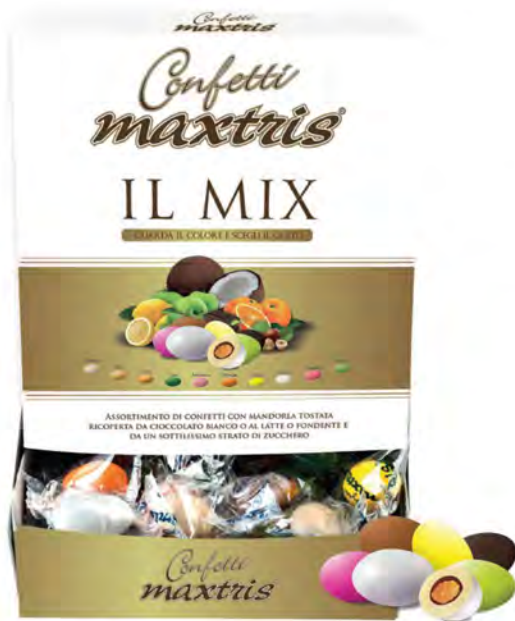

DRAGÈES MIX SINGLE WRAPPED IN FLOWPACK

Toasted almond in white chocolate in mix flavors: (cherry, orange, lemon, coconut, strawberry, green apple, gold (milk chocolate), nut (milk chocolate gianduia), noir (dark chocolate), classic (white and dark chocolate) in a thin and colored layer of sugar. Single wrapped

Your colour, your taste



COD	DESCRIZIONE	EAN cod. ESP. EAN cod. UV
CBLMIX	Cartone Espositore BOCCA di LUPO DRAGES MAXTRIS MIX 1500gX3 Pz	8022470218237 8022470229042
Ct. x strato	Strati x pallet	Ct. x pallet
9	6	54

GIFT BOX

Avola 40 limited edition Gran Riserva



AVOLA 40 GRAN RISERVA 1KG (GLUTEN FREE)
Fine Avola peeled almond (Caliber 40) in a very thin layer of sugar, produced according to the best tradition of Confezziera art.

PZ/KG ca: 380

AVOLA 40



MAXTRIS VANITY REGAL 800G (GLUTEN FREE)

Tasting box with eight compartments assorted in different tastes and colors: nuances of lilac, orange, green, pink, blue, yellow, red and ivory.



MAXTRIS VANITY REGAL 4 GUSTI 400G (GLUTEN FREE)

Les noisettes, maxtris classica, almond dragees Royal, chocopistachio.



CALENDARIO DELL'AVVENTO 288g
Advent Calendar with Maxtris Chocolate.



PATISSERIE REGAL 550G (GLUTEN FREE)

Regal box containing: Maxtris Ricotta e Pera, Maxtris Babà con panna, Maxtris Caffè espresso, Maxtris Yogurt ai frutti di bosco, Maxtris Cocca, Maxtris Los Palmaritos 72%, Maxtris Caramello e Sale, Maxtris Delizia al limone, Maxtris Pistacchio, Les Noisettes, Maxtris Amarena, Maxtris Cassata Siciliana, Maxtris Pastiera Napoletana, Maxtris Mirtillo, Maxtris Nut, Maxtris Caramello e Pera

GIFT BOX



MAXTRIS | CIOCCOLATI 600G (GLUTEN FREE)

Mixed chocolate (milk, ruby, the matcha, white dark and caramel) with hazelnut and almond.



COD U.V.	EAN cod. U.V.	
CIOCBOX600	8022470246568	
U.M.	KG netti U.V.	Pz. x crt.
pz	0,6	4
Ct. x strato	Strati x pallet	Ct. x pallet
12	5	60



MAXTRIS TRUFFLE BAKERY 500G (GLUTEN FREE)

Mix truffled with cake tastes.



COD U.V.	EAN cod. U.V.	
BAKBOX500	8022470246520	
U.M.	KG netti U.V.	Pz. x crt.
pz	0,5	3
Ct. x strato	Strati x pallet	Ct. x pallet
10	6	60



MAXTRIS CHOCOLATE COLLECTION 800G (GLUTEN FREE)

Mixed almonds, hazelnuts, cashews, pistachios, candied cherries in dark, milk and white chocolate.

TRUFFLE BOX 500G (GLUTEN FREE)

Mixed truffled with cherry candied, hazelnut, almond, nut and cashewnut.



COD U.V.	EAN cod. U.V.	
TRUBOX500	8022470246513	
U.M.	KG netti U.V.	Pz. x crt.
pz	0,5	3
Ct. x strato	Strati x pallet	Ct. x pallet
10	6	60



COD U.V.	EAN cod. U.V.	
PRAVAN8	8022470243529	
U.M.	KG netti U.V.	Pz. x crt.
pz	0,8	4
Ct. x strato	Strati x pallet	Ct. x pallet
9	6	54

GIFT BOX

BLACK AND WHITE 400g

(GLUTEN FREE)

Mix of coconut and brownies truffles in white and dark chocolate.



FIOCCHO DI NEVE



BROWNIES

COD. U.V.	EAN cod. U.V.	
BWBOX400	8022470252132	
U.M.	KG netti U.V.	Pz. x crt.
pz	0,4	3
Ct. x strato	Strati x pallet	Ct. x pallet
16	6	60

INCLUSION 600g

(GLUTEN FREE)

Mix truffled with cherry candied, hazelnut, almond, nut and cashewnut.



HAZELNUT CARAMEL



HAZELNUT WITH
CHOPPED HAZELNUT



HAZELNUT WITH
CHOPPED PISTACHE



ALMOND CARAMEL



ALMOND WITH
CHOPPED HAZELNUT



ALMOND WITH
CHOPPED PISTACHE



COD. U.V.	EAN cod. U.V.	
INCBOX600	8022470252156	
U.M.	KG netti U.V.	Pz. x crt.
pz	0,6	3
Ct. x strato	Strati x pallet	Ct. x pallet
10	6	60



MAXTRIS CHOCOLATE COLLECTION 800g

(GLUTEN FREE)

Mixed almonds, hazelnuts, cashews, pistachios, candied cherries in dark, milk and white chocolate.



HAZELNUT
MILK



HAZELNUT
DARK



HAZELNUT
WHITE



ALMOND
DARK



CHERRY
DARK

TWIST BAG

1 Kg Bags



HAZELNUT MILK
Toasted hazelnut in milk chocolate.



ALMOND DARK
Toasted almond in dark chocolate.



NOUGAT MILK
Hazelnut crunchy in milk chocolate.



NOUGAT DARK
Hazelnut crunchy in dark chocolate.

TWIST classic

1 Kg Bags

MAXTRIS TWIST

Toasted almond in dark and white chocolate in a thin layer of sugar.

Colours Available:



TWIST BAG

1 Kg Bags



CONFEZIONE TWIST RICOTTA E PERA

Toasted almond in white pear ricotta cake flavored chocolate in a thin layer of sugar.



CONFEZIONE TWIST PISTACCHIO

Toasted almond in white pistachio flavored chocolate in a thin layer of sugar.



CONFEZIONE TWIST NUT

Toasted almond in gianduja milk chocolate in a thin layer of sugar.



CONFEZIONE TWIST SBAGLIATO

Toasted almond in milk and gianduja chocolate With chopped hazelnuts, dark chocolate in a thin layer of sugar.



CONFEZIONE TWIST MIX PASTICCERIA

Toasted almond in dark or white different tastes flavored chocolate (zuppa inglese cake, espresso coffee, pistachio, straciatella and tiramisù) in a thin layer of sugar.



CONFEZIONE TWIST MIX FRUTTA

Toasted almond in white mix fruit flavored chocolate (cherry, strawberry, banana, orange, coconut, lemon, green apple) in a thin layer of sugar.



CONFEZIONE TWIST MIX CHOCO

Toasted almond in a mix different chocolate in a thin layer of sugar.



CONFEZIONE TWIST MIX

Toasted almond in milk or dark or white different tastes flavored chocolate (classic, cherry, orange, lemon, coconut, strawberry, green apple, milk, nut, noir) in a thin layer of sugar.



CONFEZIONE TWIST AFFOGATO AL CIOCCOLATO

Toasted almond in white and milk chocolate in a thin layer of sugar.



CONFEZIONE TWIST TIRAMISÙ

Toasted almond in white tiramisù flavored chocolate in a thin layer of sugar.



CONFEZIONE TWIST MIX LA SICILIANITÀ

Toasted almond in white different tastes flavored chocolate (cannolo siciliano, cassata siciliana, pistachio, orange and lemon) in a thin layer of sugar.



CONFEZIONE TWIST MIX LA NAPOLETANITÀ

Toasted almond in dark or white different tastes flavored chocolate (babà with cream, pastiera napoletana, cheese and pear cake, sfogliatella napoletana and caprese cake) in a thin layer of sugar.

Coffee Chocolate



COFFEE CHOCOLATE 250 g
Coffee beans in dark chocolate.

COD U.V.	DESCRIZIONE	EAN cod. PZ EAN cod. U.V.
CVCHOCOF250	CARTONE VASSOIO Praline di Caffè al cioccolato fondente incartati singolarmente N 8 X 250g	8022470229424 8022470233353
U.M.	KG netti U.V.	Pz. x crt.
pz	2	8
Ct. x strato	Strati x pallet	Ct. x pallet
6	5	30

BIG BAG COFFEE CHOCOLATE (1 Kg)
Coffee grain in dark chocolate. Single wrapped

COD U.V.	DESCRIZIONE	EAN cod. PZ EAN cod. U.V.
CBCHOCOF	CARTONE con n. 5 BUSTE Praline di Caffè al cioccolato fondente incartati singolarmente 1000g	8022470238358 8022470238662
U.M.	KG netti U.V.	Pz. x crt.
pz	5kg	5
Ct. x strato	Strati x pallet	Ct. x pallet
6	5	30



TARTUFINI

500g Pack



TARTUFINI CILIEGIA (GLUTEN FREE)
Candied cherries in dark chocolate, dusted with cocoa powder.



TARTUFINI NOCCIOLA (GLUTEN FREE)
Hazelnuts in dark chocolate, dusted with cocoa powder.



TARTUFINI MANDORLA (GLUTEN FREE)
Almonds in dark chocolate and dusted with cocoa powder.



TARTUFINI NOCE (GLUTEN FREE)
Walnuts in dark chocolate, dusted with cocoa powder.

TARTUFINI

500g Pack



TARTUFINI RICOTTA E PERA (GLUTEN FREE)
Almonds in white cheese and pear
flavored chocolate and dusted with icing sugar.



TARTUFINI BABÀ CON PANNA (GLUTEN FREE)
Almonds in white babà with cream
flavored chocolate and dusted with icing sugar.



TARTUFINI COCCO (GLUTEN FREE)
Almonds in white coconut flavored
chocolate and dusted with icing sugar.



TARTUFINI PISTACHIO (GLUTEN FREE)
Almonds in white pistachio flavored
with icing sugar.



TARTUFINI TIRAMISÙ (GLUTEN FREE)
Almonds in white tiramisù flavored chocolate
and dusted with cocoa powder.



TARTUFINI CASSATA SICILIANA (GLUTEN FREE)
Almonds in white Cassata Siciliana flavored
chocolate and dusted with icing sugar.



TARTUFINI YOGURT AI FRUTTI DI BOSCO (GLUTEN FREE)
Almonds in white yogurt wildberry
flavored chocolate, dusted with icing sugar.



TARTUFINI NUT (GLUTEN FREE)
Almond in milk gianduja chocolate, dusted with cocoa powder

LA PRALINERIA

1Kg / 3Kg / 5Kg packs



AVAILABLE CHOCOLATE
 WHITE CHOCOLATE
 MILK CHOCOLATE
 DARK CHOCOLATE
 MIX CHOCOLATE



PRALINE MAXTRIS 1 KG

Mix candied dried fruit in white, milk and dark chocolate.

3 KG PACK / BULK 5 KG

Dragees and Truffle box.

TARTUFINI CHERRY

Candied Cherry covered with dark chocolate and cocoa dusted.

● DARK COD U.V. LTARSPOMAF3



TARTUFINI HAZELNUT

Hazelnut covered with dark or milk chocolate, and cocoa dusted.

● MILK COD U.V. LTARSPONOC13

● DARK COD U.V. LTARSPONOCF3



TARTUFINI ALMOND

Almond covered with dark chocolate or caramel and salt, and cocoa dusted.

● DARK COD U.V. LTARSPOMANF3

● CAMELL & SALT COD U.V. LTARSPOMANC3



TARTUFINI WALNUT

Walnut covered with dark chocolate, and cocoa dusted.

● DARK COD U.V. LTARSPONOCEF3



TARTUFINI CASHEW

Cashew covered with milk chocolate and cocoa dusted.

● MILK COD U.V. LTARSPOANL3



NOUGAT

Nougat covered with milk chocolate and cocoa dusted.

● MILK COD U.V. LTARSPONOUGL3



TARTUFINI CHOCOCOCO

Soft coconut covered with milk chocolate and cocoa dusted.

● MILK COD U.V. LTARSPOCOCL3



HAZELNUT THE MATCHA

Toasted hazelnut covered with the matcha chocolate.

● THÈ MATCHA COD U.V. LTARSPONOCHE3



LA PRALINERIA

1Kg / 3Kg / 5Kg packs

TARTUFINI PEAR CHEESECAKE

Pear cube covered with cheesecake chocolate and cocoa dusted.

WHITE COD U.V. LTARSPORIC3



TARTUFINI COCONUT

Soft Coconut cube covered with a first layer of dark chocolate and second layer with white chocolate and dusted with coconut powder.

DARK & WHITE COD U.V. LTARSPCONUT3



TARTUFINI SACHER

Soft apricot gelee covered with dark sacher chocolate and cocoa dusted.

DARK COD U.V. LTARSPSAC3



TARTUFINI LEMON'S CAKE

Soft lemon gelee covered with white lemon's cake chocolate and fruit dust.

WITH COD U.V. LTARSPODEL3



CASHEW DRAGEES

Cashew covered with caramel and salt chocolate.

CARAMEL & SALT COD U.V. LANACS3



DRAGEES NOUGAT

Nougat covered with dark or milk chocolate.

DARK COD U.V. LNOUGF3
MILK COD U.V. LNOUGL3



HAZELNUT DRAGEES

Toasted hazelnut covered with a layer of chocolate.

MILK COD U.V. LNOCL3
MIX COD U.V. LNOCASS3
WHITE COD U.V. LNOCB3
DARK COD U.V. LNOCF3



DRAGEES MANDORLA MAXI

Toasted hazelnut covered with a layer of chocolate.

MILK COD U.V. LMANL3
MIX COD U.V. LMANASS3
WHITE COD U.V. LMANB3
DARK COD U.V. LMANF3



DRAGEES AMARENA MAXI

Candied cherry covered with a layer of chocolate.

WHITE COD U.V. LAMAB3
MILK COD U.V. LAMAL3
DARK COD U.V. LAMAF3
MIX COD U.V. LAMAASS3



DRAGEES CAFFÈ

Toasted coffee beans covered with a layer of chocolate.

WHITE COD U.V. LCAFB3 MILK COD U.V. LCAFL3
DARK COD U.V. LCAFF3 MIX COD U.V. LCAFASS3



DRAGEES RAISIN

Raisin covered with a thin layer of chocolate.

MILK COD U.V. LUVAL3
MIX COD U.V. LUVAASS3
WHITE COD U.V. LUVAB3
DARK COD U.V. LUVAF3



LEMON LIQUOR DRAGEE

Lemon liquor covered with dark chocolate.

DARK COD U.V. LLIQLIM3

ALCOHOLIC



SAMBUCA LIQUOR DRAGEE

Sambuca liquor covered with white chocolate.

WHITE COD U.V. LLIQSAM3

ALCOHOLIC



LA PRALINERIA

1Kg / 3Kg / 5Kg packs

STREGA LIQUOR DRAGEE

Strega liquor covered with white and milk chocolate.

WHITE & MILK COD U.V. LLIQSTR3



RHUM LIQUOR DRAGEE

Rhum liquor covered with milk chocolate.

MILK COD U.V. LLIQRHU3



MIX LIQUOR DRAGEE

Rhum liquor covered with milk chocolate; Lemon liquor covered with dark chocolate; Strega liquor covered with white and milk chocolate; Sambuca liquor covered with white chocolate.

MIX COD U.V. LLIQASS3

ALCOHOLIC



RHUM LIQUOR DRAGEE IN DARK CHCOLATE (MIN. COCOA 70%)

Rhum liquor covered with dark chocolate (minimum cocoa 70%), in a thin layer of sugar.

DARK COD U.V. LMAXLRHU3

ALCOHOLIC



CHERRY LIQUOR DRAGEE IN DARK CHCOLATE (MIN. COCOA 70%)

Cherry liquor covered with dark chocolate (minimum cocoa 70%), in a thin layer of sugar.

DARK COD U.V. LMAXLCHE3

ALCOHOLIC



COFFEE LIQUOR DRAGEE IN DARK CHCOLATE (MIN. COCOA 70%)

Coffee liquor covered with dark chocolate (minimum cocoa 70%), in a thin layer of sugar.

DARK COD U.V. LMAXLCAF3

ALCOHOLIC



PARTY LINE

1 Kg / 500g / 400g Pack

YOUR COLOUR, YOUR TASTE



CIOCIÒ AL LATTE (GLUTEN FREE)

Milk chocolate in lens shape, in a thin layer of sugar.



MINI CIOCIÒ AL LATTE (GLUTEN FREE)

Milk chocolate in mini lens shape, in a thin layer of sugar.



COCONUT



STRAWBERRY



GREEN APPLE



ORANGE



LEMON

CIOCOPISTACCHIO

500g



CIOCOPISTACCHIO BIANCO (Gluten Free)

Pistachio in white chocolate in a thin layer of sugar.

Cod. art. CIOPISB500 Cod. EAN 8022470235937



CIOCOPISTACCHIO BIANCO (Gluten Free)

Pistachio in white chocolate in a thin layer of sugar.

Cod. art. CIOPISC500 Cod. EAN 8022470235951



CIOCOPISTACCHIO BIANCO (Gluten Free)

Pistachio in white chocolate in a thin layer of sugar.

Cod. art. CIOPISR500 Cod. EAN 8022470235968



CIOCOPISTACCHIO BIANCO (Gluten Free)

Pistachio in white chocolate in a thin layer of sugar.

Cod. art. CIOPISR500 Cod. EAN 8022470235975



CIOCOPISTACCHIO BIANCO (Gluten Free)

Pistachio in white chocolate in a thin layer of sugar.

Cod. art. CIOPISV500 Cod. EAN 8022470235948

PARTY LINE

1 Kg / 500g / 400g Pack



MAXTRIS CHOCO STARS MIX 500 g
(GLUTEN FREE)
Milk chocolate stars covered with sugar.



MAXTRIS CHOCO SPLASH MIX 500 g
(GLUTEN FREE)
Milk chocolate fish covered with sugar.



MAXTRIS BROWNIE MIX 500 g
(GLUTEN FREE)
Brownies coated with white chocolate and covered with sugar.



MAXTRIS CHOCO COCO MIX 500 g
(GLUTEN FREE)
Coconut dices coated with milk chocolate in a thin layer of sugar.



PARTY LINE

1 Kg / 500g / 400g Pack



MAXTRIS CHOCK BON MIX 400g
Cereal balls coated with milk chocolate.



MAXTRIS CANDY GELEE 500g
Gummy candy coated with milk chocolate and covered with sugar.



CHOCO LOVE AZZURRI 500g
Milk chocolate little hearts covered with sugar.



CHOCO LOVE ARANCIO 500g
Milk chocolate little hearts covered with sugar.



CHOCO LOVE ROSA 500g
Milk chocolate little hearts covered with sugar.



CHOCO LOVE VIOLA 500g
Milk chocolate little hearts covered with sugar.



CHOCO LOVE ROSSI 500g
Milk chocolate little hearts covered with sugar.



CHOCO LOVE VERDI 500g
Milk chocolate little hearts covered with sugar.



CHOCO LOVE AVORIO 500g
Milk chocolate little hearts covered with sugar.



CHOCO LOVE GIALLO 500g
Milk chocolate little hearts covered with sugar.

PARTY LINE

1 Kg / 500g / 400g Pack

MAXTRIS DOLCI STELLE 500 g (GLUTEN FREE)

Stars of milk chocolate in a thin layer of sugar.

Cod. art. VSTEB500

Cod. EAN 8022470253801



MAXTRIS DOLCI STELLE 500 g (GLUTEN FREE)

Stars of milk chocolate in a thin layer of sugar.

Cod. art. VSTEC500

Cod. EAN 8022470253825



MAXTRIS DOLCI STELLE 500 g (GLUTEN FREE)

Stars of milk chocolate in a thin layer of sugar.

Cod. art. VSTER500

Cod. EAN 8022470253818



MAXTRIS DOLCI STELLE 500 g (GLUTEN FREE)

Stars of milk chocolate in a thin layer of sugar.

Cod. art. VSTERS500

Cod. EAN 8022470253832

MAXTRIS NEWS

1Kg pack



NEW

MAXTRIS SBAGLIATO (GLUTEN FREE)
Toasted almond in milk and glanduja chocolate with chopped hazelnuts, dark chocolate, in a thin layer of sugar.



NEW

ANACARDO - CASHEW (GLUTEN FREE)
Toasted cashew in caramel chocolate, in a thin layer of sugar.



NEW

MAXTRIS AFFOGATO ALL'AMARENA (GLUTEN FREE)
Toasted almond in white cream and black cherry flavored chocolate, in a thin layer of sugar.



NEW

MAXTRIS AFFOGATO AL CIOCCOLATO (GLUTEN FREE)
Toasted almond in white and milk chocolate, in a thin layer of sugar.



NEW

MAXTRIS PANCAKE E SCIROPPLO D'ACERO (GLUTEN FREE)
Toasted almond white pancake and maple syrup flavored chocolate, in a thin layer of sugar.



NEW

MAXTRIS BURRO D'ARACHIDI E MARMELLATA (GLUTEN FREE)
Toasted almond in white peanut butter and marmelade flavored chocolate in a thin layer of sugar.



NEW

MAXTRIS MANDORLA SALATA E CARAMELLO (GLUTEN FREE)
Toasted salted almond in caramel chocolate, in a thin layer of sugar.



NEW

MAXTRIS MARZAPANE (GLUTEN FREE)
Soft marzipan in dark chocolate in a thin layer of sugar.



NEW

MAXTRIS SBAGLIATO TIRAMISÙ (GLUTEN FREE)
Toasted almond in chocolate with chopped coffee in a thin layer of sugar.



NEW

MAXTRIS SBAGLIATO BISCOTTINO (GLUTEN FREE)
Toasted almond in chocolate with chopped biscuits in a thin layer of sugar.



MAXTRIS SBAGLIATO WILDBERRIES (GLUTEN FREE)
Toasted almond in chocolate with chopped wildberries, in a thin layer of sugar.



NEW

MAXTRIS SBAGLIATO PISTACHIO (GLUTEN FREE)
Toasted almond in chocolate with chopped pistachio in a thin layer of sugar.

MAXTRIS LINE

1Kg pack

FRUIT



MAXTRIS WALNUT (GLUTEN FREE)
Toasted almond in white walnut flavored chocolate, in a thin layer of sugar.



MAXTRIS CHERRY (GLUTEN FREE)
Toasted almond in white cherry flavored chocolate, in a thin layer of sugar.



MAXTRIS PINEAPPLE (GLUTEN FREE)
Toasted almond in white pineapple flavored chocolate, in a thin layer of sugar.



MAXTRIS WATERMELON (GLUTEN FREE)
Toasted almond in white watermelon flavored chocolate, in a thin layer of sugar.



MAXTRIS YOGURT RED BERRIES (GLUTEN FREE)
Toasted almond in white yogurt berries flavored chocolate, in a thin layer of sugar.



MAXTRIS PISTACCHIO E GIANDUIA (GLUTEN FREE)
Toasted almond in white pistachio flavored chocolate and in gianduja milk chocolate, in a thin layer of white sugar.



MAXTRIS COCONUT (GLUTEN FREE)
Natural almond in white coconut flavored chocolate, in a thin layer of white sugar.



MAXTRIS STRAWBERRY (GLUTEN FREE)
Toasted almond in white strawberry flavored chocolate, in a thin layer of sugar.



MAXTRIS PEACH (GLUTEN FREE)
Toasted almond in white peach flavored chocolate, in a thin layer of sugar.



MAXTRIS ORANGE (GLUTEN FREE)
Toasted almond in white orange flavored chocolate, in a thin layer of sugar.



MAXTRIS VANILLA RASPBERRY (GLUTEN FREE)
Toasted almond in white vanilla raspberry flavored chocolate, in a thin layer of sugar.



MAXTRIS LEMON (GLUTEN FREE)
Toasted almond in white lemon flavored chocolate, in a thin layer of sugar.



MAXTRIS LIQUORICE AND MINT (GLUTEN FREE)
Toasted almond in white licorice and mint flavored chocolate, in a thin layer of sugar.



MAXTRIS PISTACHIO (GLUTEN FREE)
Toasted almond in white pistachio flavored chocolate, in a thin layer of sugar.



MAXTRIS PEAR AND CINNAMON (GLUTEN FREE)
Toasted almond in white pear and cinnamon flavored chocolate, in a thin layer of sugar.



MAXTRIS GREEN APPLE (GLUTEN FREE)
Toasted almond in white green apple flavored chocolate, in a thin layer of sugar.



MAXTRIS BLUEBERRY (GLUTEN FREE)
Toasted almond in white blueberry flavored chocolate, in a thin layer of sugar.

PASTRY



MAXTRIS SICILIAN CANNOLO (GLUTEN FREE)
Toasted almond in dark chocolate and white Sicilian cannolo flavored chocolate, in a thin layer of sugar.



MAXTRIS CARAMEL AND SALT (GLUTEN FREE)
Toasted almond in milk caramel and salt flavored chocolate, in a thin layer of sugar.



MAXTRIS SICILIAN CAKE (GLUTEN FREE)
Toasted almond in white Sicilian cake flavored chocolate, in a thin layer of sugar.

MAXTRIS LINE

1Kg pack

CHOCOLATE/PLAIN



MAXTRIS GOLD/MILK CHOCOLATE
(GLUTEN FREE)
Toasted almond in milk chocolate in a thin layer of sugar.



MAXTRIS NOIR/DARK CHOCOLATE
(GLUTEN FREE)
Toasted almond in dark chocolate, in a thin layer of sugar.



MAXTRIS NUT/GIANDUIA CHOCOLATE (GLUTEN FREE)
Toasted almond in milk chocolate and milk gianduja chocolate, in a thin layer of sugar.



MAXTRIS HAZELNUT CHOCOLATE
(GLUTEN FREE)
Toasted almond in milk chocolate and milk gianduja chocolate, in a thin layer of sugar.



MAXTRIS DARK CHOCOLATE AND WHITE CREAM (GLUTEN FREE)
Toasted almond in dark chocolate and white cream flavored chocolate, in a thin layer of sugar.



MAXTRIS WHITE, DARK AND MILK CHOCOLATE (GLUTEN FREE)
Toasted almond in white, dark and milk chocolate, covered by a thin layer of sugar.



MAXTRIS WHITE AND DARK CHOCOLATE/MINI (GLUTEN FREE)
Toasted almond in white and dark chocolate, in a thin layer of white sugar.



MAXTRIS WHITE AND DARK CHOCOLATE PINK/MINI (GLUTEN FREE)
Toasted almond in white and dark chocolate, in a thin layer of pink sugar.

COLORI ESISTONO DISPONIBILI



MAXTRIS WHITE AND DARK CHOCOLATE RED /MINI (GLUTEN FREE)
Toasted almond in white and dark chocolate, in a thin layer of red sugar.



MAXTRIS WHITE AND DARK CHOCOLATE GREEN /MINI (GLUTEN FREE)
Toasted almond in white and dark chocolate, in a thin layer of green sugar.



MAXTRIS WHITE AND DARK CHOCOLATE BLUE /MINI (GLUTEN FREE)
Toasted almond in white and dark chocolate, in a thin layer of sugar.

MIXED



MAXTRIS MIX DELICE
(GLUTEN FREE)
Mix of dragees with toasted almond in white different tastes flavored chocolate (pistachio, blueberry, cheesecake, pear cheesecake, delizia a limone, berries yogurt and muffin) or in white chocolate and gianduja milk chocolate (coconut), in a thin layer of sugar.



MAXTRIS MIX MARBLED
(GLUTEN FREE)
Toasted almond in white chocolate in mix flavors (ricotta cheese and pear, berries yogurt, babà with cream, lemon delizia, Sicilian cassata), in a thin and colored layer of sugar.



MAXTRIS FRUITS (GLUTEN FREE)
Toasted almond in white mix fruit flavored chocolate (cherry, strawberry, banana, orange, coconut, lemon, green apple), in a thin layer of sugar.

COLORS AVAILABLE



MAXTRIS BLACK & WHITE
(GLUTEN FREE)
Toasted almond in white and dark chocolate, in a thin layer of white and dark sugar.



PENSIERO DI CAPRI (GLUTEN FREE)
Toasted almond in white lemon or orange flavored chocolate, in a thin layer of sugar.



MAXTRIS WHITE AND DARK CHOCOLATE
(GLUTEN FREE)
Toasted almond in white and dark chocolate, in a thin layer of colored sugar.



MAXTRIS MIX (Gluten Free)
 Toasted almond in white chocolate in mix flavors: (cherry, orange, lemon, coconut, strawberry, green apple, gold (milk chocolate), nut (milk chocolate glandula), noir (dark chocolate), classic (white and dark chocolate) in a thin and colored layer of sugar.



MAXTRIS MIX PASTRY (Gluten Free)
 Toasted almond in white or dark mix pastry flavored chocolate: (zuppa inglese, coffee, pistachio, stracciatella, tiramisù) in a thin layer of colored sugar.



MAXTRIS LA SICILIANITÀ (Gluten Free)
 Mix of dragees with toasted almond in white different tastes flavored chocolate (Cannolo siciliano, cassata siciliana, pistacchio, arancia e limone) in a thin layer of sugar.



MAXTRIS NEAPOLITAN'S DESSERTS (Gluten Free)
 Toasted almond in white chocolate in mix flavors of Neapolitan's desserts (babà with cream, Neapolitan pastiera, ricotta cheese and pear, sfogliatella) and dark Caprese cake flavored chocolate, in a thin layer of sugar.

NUANCE

1Kg pack



MAXTRIS NUANCE WAVE (Gluten Free)
 Toasted almond in white or dark or milk and glandula milk chocolate in mix flavours and colours: coffee, dark cookie, coconut and classico in a thin layer of sugar.

Your color, your taste



MAXTRIS NUANCE CAMELIA (Gluten Free)
 Toasted almond in white or dark chocolate in mix flavours and colours: cheesecake, cheese and pear, tiramisù, classico in a thin layer of sugar.

Your color, your taste



MAXTRIS NUANCE GARDEN (Gluten Free)
 Toasted almond in white or dark or and glandula milk chocolate in mix flavours and colours: zuppa inglese, sfogliatella, macaroons and nougat in a thin layer of sugar.

Your color, your taste



SFUMATI

1Kg pack



MAXTRIS SFUMATI AVORIO (GLUTEN FREE)

Toasted almond in white or dark chocolate in mix flavours: classic, crema catalana, melon, and pastry vanilla) in a thin layer of sugar, in different nuances of ivory.

Your color, your taste



MAXTRIS SFUMATI ROSSO (GLUTEN FREE)

Toasted almond in white or milk chocolate in mix flavours: (nut, creme caramel, caramello e fleur de sel) in a thin layer of sugar, in different nuances of red.

Your color, your taste



MAXTRIS SFUMATI LILLA (GLUTEN FREE)

Toasted almond in white chocolate in mix flavours: raspberries, red grapes, passion fruit, berries yogurt, covered by a thin layer of sugar, in different nuances of lilac.

Your color, your taste



MAXTRIS SFUMATI GIALLO (GLUTEN FREE)

Toasted almond in white or milk chocolate in mix flavours: zuppa inglese, sfogliatella, macaroons and nougat) in a thin layer of sugar, in different nuances of yellow.

Your color, your taste



MAXTRIS SFUMATI ARANCIONE (GLUTEN FREE)

Toasted almond in white chocolate in mix flavours: (orange, peach, babà with cream, straciatella) in a thin layer of sugar, in different nuances of orange.

Your color, your taste



MAXTRIS SFUMATI ROSA (GLUTEN FREE)

Toasted almond in white chocolate in mix flavours: strawberry, sour cherry, blueberry, cheesecake, covered by a thin layer of sugar, in different nuances of pink.

Your color, your taste



MAXTRIS SFUMATI VERDE (GLUTEN FREE)

Toasted almond in white chocolate in mix flavours: lemon, pistachio, ricotta cheese and pear, Sicilian cassata, covered by a thin layer of sugar, in different nuances of green.

Your color, your taste



MAXTRIS SFUMATI AZZURRO (GLUTEN FREE)

Toasted almond in white chocolate in mix flavours: coconut, Sicilian cannolo, tiramisù, lemon delizia, covered by a thin layer of sugar, in different nuances of blue.

Your color, your taste



COCKTAIL LINE

ALCOHOL FREE

1Kg pack



MAXTRIS PINACOLADA (GLUTEN FREE)
Toasted almond in white Piña colada flavored chocolate, in a thin layer of sugar.



MAXTRIS MOJITO (GLUTEN FREE)
Toasted almond in white Mojito flavored chocolate, in a thin layer of sugar.



MAXTRIS SPRITZ (GLUTEN FREE)
Toasted almond in white Spritz flavored chocolate, in a thin layer of sugar.

NEW



MAXTRIS MOSCOW MULE (GLUTEN FREE)
Toasted almond in white MoscowMule flavored chocolate, in a thin layer of sugar.

NEW



MAXTRIS BUBBLE (GLUTEN FREE)
Toasted almond in white champagne flavored chocolate, in a thin layer of sugar.

WINE LINE

ALCOHOLIC

500g pack



MAXTRIS WHITE WINE/FILLED (GLUTEN FREE)
Toasted almond in white MoscowMule chocolate, in a thin layer of sugar.

NEW



MAXTRIS RED WINE/FILLED (GLUTEN FREE)
Toasted almond in white MoscowMule chocolate, in a thin layer of sugar.

NEW

LES NOISETTES

Confezioni da 1Kg / 1Kg pack



NOISETTES GIANDUIA (GLUTEN FREE)
Hazelnut in milk chocolate and hazelnut cream, in a thin layer of sugar.



LES NOISETTES CLASSIC (GLUTEN FREE)
Hazelnut in white and dark chocolate, in a thin layer of sugar.
AVAILABLE COLOURS
White, Pink, Light blue, Red, Green, Mix

LOVE FRUITS

1Kg pack

Real piece fruit covered with chocolate



MAXTRIS AMARENA FABBRI BIANCO (GLUTEN FREE)
Unique and traditional taste Fabbri,
covered with dark chocolate and a thin layer of sugar.



MAXTRIS AMARENA FABBRI CELESTE (GLUTEN FREE)
Unique and traditional taste Fabbri,
covered with dark chocolate and a thin layer of sugar.



MAXTRIS AMARENA FABBRI FUCSIA (GLUTEN FREE)
Unique and traditional taste Fabbri,
covered with dark chocolate and a thin layer of sugar.



MAXTRIS AMARENA FABBRI ROSA (GLUTEN FREE)
Unique and traditional taste Fabbri,
covered with dark chocolate and a thin layer of sugar.



MAXTRIS AMARENA FABBRI ROSSO (GLUTEN FREE)
Unique and traditional taste Fabbri,
covered with dark chocolate and a thin layer of sugar.



LOVE FRUITS COCCONETTE/COCONUT
(GLUTEN FREE)
Piece of coconut piece in white chocolate, in thin layer of sugar.



LOVE FRUITS ARANCETTE/ORANGE
(GLUTEN FREE)
Piece of candied orange in dark chocolate, in thin layer of sugar.



LOVE FRUITS PERENETTE/PEAR
(GLUTEN FREE)
Piece of candied pear in white chocolate, in thin layer of sugar.



LOVE FRUITS LIMONCETTE/LEMON
(GLUTEN FREE)
Piece of candied lemon in white chocolate, in thin layer of sugar.

AGRUMETI

500g pack

ALCOHOLIC



GLI AGRUMETI ARANCIA/ORANGE LIQUOR FILLED (GLUTEN FREE)
A soul of orange liquor in white chocolate and a thin layer of sugar.



GLI AGRUMETI LIMONE/LEMON LIQUOR (GLUTEN FREE)
A soul of lemon liquor in white chocolate and a thin layer of sugar.

LES PERLES DE L'AMOUR

1Kg packs



LES PERLES ÈTÈ RED/GOLD (GLUTEN FREE)
Toasted hazelnut in white and dark chocolate, in a thin layer of red and gold pearled sugar.



LES PERLES ÈTÈ WHITE/GOLD
(GLUTEN FREE)



LES PERLES ÈTÈ BLACK/GOLD
(GLUTEN FREE)



LES PERLES ÈTÈ GOLD
(GLUTEN FREE)



LES PERLES ÈTÈ ROUGE
(GLUTEN FREE)



LES PERLES ÈTÈ VERT
(GLUTEN FREE)



LES PERLES ÈTÈ BLEU
(GLUTEN FREE)



LES PERLES ÈTÈ SILVER
(GLUTEN FREE)



LES PERLES ÈTÈ BLANC
(GLUTEN FREE)



LES PERLES ÈTÈ GOLDEN
(GLUTEN FREE)



LES PERLES HIVER ARGENT
(GLUTEN FREE)



LES PERLES HIVER CUIVRE
(GLUTEN FREE)



LES PERLES HIVER BRONZE
(GLUTEN FREE)



LES PERLES HIVER GOLDEN
(GLUTEN FREE)



LES PERLES HIVER GOLDEN
(GLUTEN FREE)

WINNER

Confezioni da 1Kg / 1Kg pack

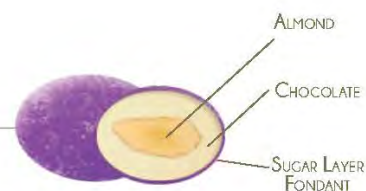

MAXTRIS WINNER MIRTILLO/BLUEBERRY
(GLUTEN FREE)

Toasted almond in white berry flavored chocolate, in a very soft layer of sugar.



MAXTRIS WINNER PISTACCHIO/PISTACHIO
(GLUTEN FREE)

Toasted almond in white pistachio flavored chocolate, in a very soft layer of sugar.

WINNER

Confezioni da 1Kg / 1Kg pack

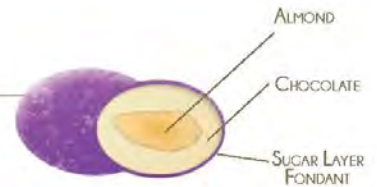

MAXTRIS WINNER LIMONE/LEMON
(GLUTEN FREE)

Toasted almond in white lemon flavored chocolate, in a very soft layer of sugar.



MAXTRIS WINNER AMARENA/BLACKCHERRY
(GLUTEN FREE)

Toasted almond in white cherry flavored chocolate, in a very soft layer of sugar.



MAXTRIS WINNER ARANCIA/ORANGE
(GLUTEN FREE)

Toasted almond in white orange flavored chocolate, in a very soft layer of sugar.



MAXTRIS WINNER CIOCCOLATO BIANCO/WHITE CHOCOLATE
(GLUTEN FREE)

Toasted almond in white chocolate, in a very soft layer of sugar.



MAXTRIS WINNER CIOCCOLATO FONDENTE/DARK CHOCOLATE (GLUTEN FREE)

Toasted almond in dark chocolate, in a very soft layer of sugar.



MAXTRIS WINNER CIOCCOLATO AL LATTE/MILK CHOCOLATE (GLUTEN FREE)

Toasted almond in milk chocolate, in a very soft layer of sugar.

MORBIDI

1Kg packs



MORBIDI LIMONE/LEMON (GLUTEN FREE)
Peeled almond dragees in a soft layer of lemon powder and thin layer of sugar.



MORBIDI PISTACCHIO/PISTACHIO (GLUTEN FREE)
Peeled almond dragees in a soft layer of pistachio powder and thin layer of sugar.

MORBIDI

1Kg packs



MAXTRIS CAFFÈ/COFFEE (GLUTEN FREE)
Peeled almond dragees in a soft layer of coffee powder and thin layer of sugar.



MORBIDI CILIEGIA/CHERRY (GLUTEN FREE)
Peeled almond dragees in a soft layer of cherry powder and thin layer of sugar.

CUBAN CORNER

500g pack
ALCOHOLIC



WEDDING CAFFÈ/FILLED (GLUTEN FREE)
A soul of coffee liqueur in a fine extra dark chocolate (cocoa min 80%), in a thin layer of sugar.

Available Colours
White



WEDDING CHERRY/FILLED (GLUTEN FREE)
A soul of cherry liqueur in a fine extra dark chocolate (cocoa min 70%), in a thin layer of sugar.

Available Colours
White



LIQORELLI WEDDING RHUM/FILLED (GLUTEN FREE)
A soul of rum liqueur in a fine extra dark chocolate (cocoa min 70%), in a thin layer of sugar.

Available Colours
White



MANDORLA WEDDING RHUM/MAXTRIS (GLUTEN FREE)
Toasted almond in extra dark rum flavored chocolate (cocoa min 70%), in thin layer of sugar.

Available Colours
White

MONORIGIN COCOA

500g - 1Kg pack



MAXTRIS ARRIBA (GLUTEN FREE)
Toasted almond in milk chocolate with notes of vanilla and cherries and nuances of butter and caramel. In a thin layer of sugar.



MAXTRIS SANTO DOMINGO (GLUTEN FREE)
Toasted almond in extra dark chocolate containing cocoa mass from Santo Domingo, in a thin layer of sugar.

SPAGNOLE

1Kg pack



40 PLUS LIMITED EDITION (GLUTEN FREE)
Fine Spanish peeled almond in a thin layer of sugar.

SPAGNOLA 40 PLUS

ROYAL LIMITED EDITION (GLUTEN FREE)
Fine Spanish peeled almond in a thin layer of sugar.

PZ/KG CA: 300

SPAGNOLA 40

SPOSA NOVELLA (GLUTEN FREE)
Spanish peeled almond in a thin layer of sugar.

PZ/KG CA: 280

SPAGNOLA 36

AVAILABLE COLOURS



White, Pink, Light blue, Red, Green, Tiffany, Yellow, Violet, Bordeaux, Blue, Silver, Gold.

SOGNO DI NOZZE (GLUTEN FREE)
Spanish peeled almond in a thin layer of sugar.

PZ/KG CA: 280

SPAGNOLA 38

AVAILABLE COLOURS



White, Pink, Light blue, Red, Green.

ROYAL (GLUTEN FREE)
Spanish peeled almond in a thin layer of sugar.

PZ/KG CA: 280

SPAGNOLA 40

AVAILABLE COLOURS



White, Pink, Light blue, Red.

ROMEO & GIULIETTA (GLUTEN FREE)
Fine Spanish peeled almond in a thin layer of sugar.

PZ/KG CA: 250

SPAGNOLA 36

ELITE (GLUTEN FREE)
Spanish peeled almond in a thin layer of sugar.

PZ/KG CA: 330

SPAGNOLA 37

AVAILABLE COLOURS



White, Pink, Light blue, Red.

DOLCE SPOSA (GLUTEN FREE)
Spanish peeled almond in a thin layer of sugar.

PZ/KG CA: 250

SPAGNOLA 35

AVAILABLE COLOURS



White, Pink, Light blue, Red.

DOLCE SPOSA GOLD (GLUTEN FREE)
Spanish peeled almond in a thin layer of sugar.

PZ/KG CA: 350

SPAGNOLA 35

AVAILABLE COLOURS



White, Pink, Light blue, Red.

SPAGNOLE

1Kg pack



PELATINA SUPER (GLUTEN FREE)
Spanish peeled almond in a thin layer of sugar.

PZ/KG CA. 350

SPAGNOLA 34

AVAILABLE COLOURS
White, Pink, Light blue, Red



PERLATI (GLUTEN FREE)
Spanish peeled almond in a thin layer of sugar.

PZ/KG CA. 280

SPAGNOLA 35

CONFETTI AVOLA

1Kg pack

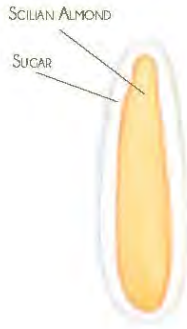

AVOLA GOLD
(GLUTEN FREE)
Fine Avola peeled almond
Caliber 40 in a thin layer of sugar.

PZ/KG CA: 280

AVOLA 40

AVOLA PENSIERO D'AMORE
(GLUTEN FREE)
Fine Avola peeled almond in a thin layer of sugar.

PZ/KG CA: 280

AVOLA 38

AVAILABLE COLOURS
White, Pink, Light blue, Red, Green.



AVOLA PENSIERO D'AMORE
AL LIQUORE DI BENEVENTO (GLUTEN FREE)
Fine Avola peeled almond in a thin layer of sugar.

PZ/KG CA: 280

AVOLA 38

AVAILABLE COLOURS
White, Pink, Light blue, Red, Green.



AVOLA PENSIERO D'AMORE
CON MANDORLA TOSTATA (GLUTEN FREE)
Fine Avola peeled almond in a thin layer of sugar.

PZ/KG CA: 280

AVOLA 38

AVOLA PETITE DELICE
(GLUTEN FREE)
Fine Avola peeled almond in a thin layer of sugar.

PZ/KG CA: 330

AVOLA 38

AVOLA EXCLUSIVE
(GLUTEN FREE)
Fine Avola peeled almond in a thin layer of sugar.

PZ/KG CA: 300

AVOLA 37

AVOLA SILVER
(GLUTEN FREE)
Fine Avola peeled almond in a thin layer of sugar.

PZ/KG CA: 350

AVOLA 36

AVAILABLE COLOURS
White, Pink, Light blue, Red



ANNIVERSARY

1Kg pack



Available for these products



LES NOISETTES GOLD LUXURY (Gluten Free)
Hazelnut in white and dark chocolate in a thin layer of glossy gold sugar.
Cod. art. NOIDORLUX500
Cod. EAN 8022470249330



MAXTRIS GOLD (Gluten Free)
Peeled almond in a thin layer of glossy gold sugar.
Calibro: 40
Cod. art. ROYDOR500
Cod. EAN 8022470218336



LE CLASSICHE ROYAL GOLD LUXURY (Gluten Free)
Peeled almond in a thin layer of glossy gold sugar.
Calibro: 40
Cod. art. ROYDOR500
Cod. EAN 8022470218336



CONFETTI AL CIOCCOLATO DORATI (Gluten Free)
Dark chocolate dragees in gold sugar.
Cod. art. CIODOR500
Cod. EAN 8022470233001



LUXURY LINE

500g pack



Available for these products



CIOCONOCCIOLA LES NOISETTES SILVER LUXURY (Gluten Free)
Hazelnut in white and dark chocolate in a thin layer of glossy silver sugar.
Cod. art. NOIARG500
Cod. EAN 8022470249842



LUXURY LINE

500g pack



LE CLASSICHE ROYAL SILVER LUXURY (Gluten Free)

Peeled almond in a thin layer of glossy silver sugar.

Calibro: 40

Cod. art. ROYARG500

Cod. EAN 8022470218343



CONFETTI AL CIOCCOLATO ARGENTATI (Gluten Free)

Dark chocolate dragees in silver sugar.

Cod. art. CIOARG500

Cod. EAN 8022470232998



LE DECORAZIONI

1Kg pack



CRISTALLI DI ZUCCHERO
Sugar crystals.

AVAILABLE COLOURS



White, Pink, Light blue, Red, Green, Orange, Yellow, Violet, Gold, Silver



SIZE 6 MM

PERLE GLOSS
Sugar gloss pearls.

AVAILABLE COLOURS



White, Pink, Light blue, Green, Orange, Yellow, Violet, Dark Green



SIZE 4 MM

PERLINE SFERICHE
Sugar pearls.

AVAILABLE COLOURS



Pink, Light blue, Green, Violet, Gold, Silver, Mix



I PERLATI

1Kg pack



Cod. art. MAXARGLUX500
Cod. EAN 8022470249347



Cod. art. MAXDORLUX500
Cod. EAN 8022470249354



Cod. art. MAXROSLUX500
Cod. EAN 8022470253795



Cod. art. MAXPERR500
Cod. EAN 8022470253771

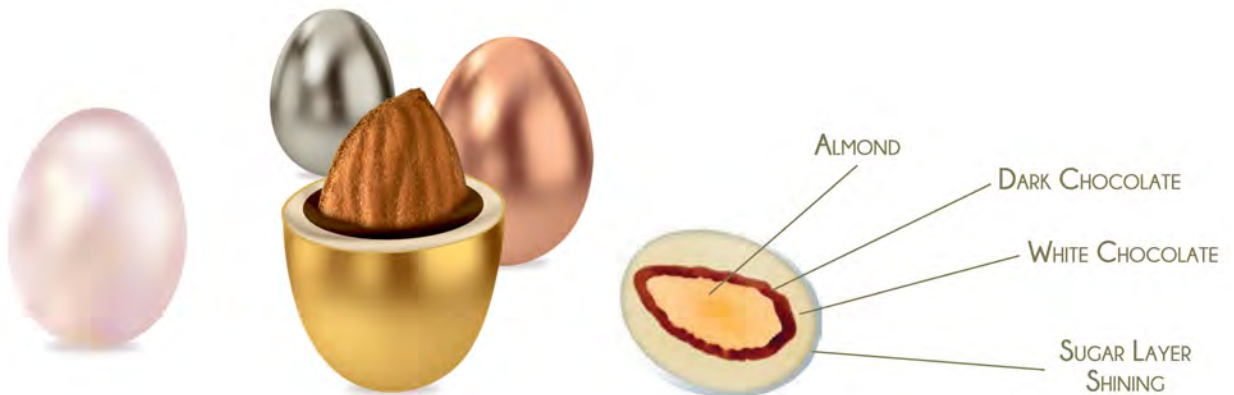

Toasted almond with dark and white chocolate and covered with a shining thin layer of sugar

FANTASY

500g/1Kg pack



CHOCK BON 900g
Cereal in milk chocolate, in a thin layer of sugar.



MAXTRIS ARACHI MIX 500g
(GLUTEN FREE)

AVAILABLE COLOURS 
White, Pink, Light blue, Red, Green, Mix



MAXTRIS CIOCOLIQUIRZIA
Licorice piece in white chocolate, in a thin layer of sugar.

CONFETTI AL CIOCCOLATO

1Kg pack



CHOCO NUANCE (GLUTEN FREE)
Dark Chocolate (70% min.) in a thin layer of sugar
in different nuances.

AVAILABLE COLOURS 
SKIN ROSE, BORDEAUX, BLUE, YELLOW, LILAC, BLUE SKY, IVORY, TIFFANY, GREEN EMERALD, ORANGE PEACH, LIGHT BLUE ICE, LIGHT BROWN, MAGENTA, BLACK

CONFETTI AL CIOCCOLATO

1Kg pack



CUORI WEDDING
MILK CHOCOLATE HEART (GLUTEN FREE)
 Milk chocolate dragees in heart shape,
 in a thin layer of sugar.



ONE CIOK (GLUTEN FREE)
 Milk chocolate dragees in almond shape,
 in a thin layer of sugar.



CIOCCOLATO FONDENTE CLASSICO
DARK CHOCOLATE (GLUTEN FREE)
 Dark chocolate dragees in a thin layer of sugar.

AVAILABLE COLOURS

White, Pink, Light blue, Red, Green, Mix



CUORI PICCOLI
SMALL HEART (GLUTEN FREE)
 Dark chocolate dragees in little heart shape, in a thin layer of sugar.

AVAILABLE COLOURS

White, Pink, Light blue, Red, Green, Mix



TESORINI
MEDIUM HEART (GLUTEN FREE)
 Dark chocolate dragees in little heart shape, in a thin layer of sugar.

AVAILABLE COLOURS

White, Pink, Light blue, Red, Green, Mix

TWO MILK

1Kg pack



TWO MILK CRUNCH MOCACCINO (GLUTEN FREE)
 Dark chocolate with pieces of cotton candy and white chocolate, in a thin layer of sugar.



TWO MILK CRUNCH WILDBERRY (GLUTEN FREE)
 White chocolate with pieces of biscuit and dark chocolate, in a thin layer of sugar.



TWO MILK CRUNCH CHOPPED HAZELNUT (GLUTEN FREE)
 White chocolate with pieces of crispy caramel and milk chocolate, in a thin layer of sugar.



TWO MILK UNICORN (GLUTEN FREE)
 White chocolate in milk chocolate in a thin layer of sugar.



TWO MILK RED VELVET (GLUTEN FREE)
 An inner layer of white chocolate and white red velvet flavoured chocolate, in a thin layer of sugar



TWO MILK CLASSICO / CLASSIC (GLUTEN FREE)
 White and milk chocolate in a thin layer of sugar.

AVAILABLE COLOURS
 White, Pink, Light blue, Red, Green, Mix

TWO MILK

1Kg pack



**TWO MILK CRUNCH
COTTON CANDY (GLUTEN FREE)**

Dark chocolate with pieces of cotton candy and white chocolate, in a thin layer of sugar.



**TWO MILK CRUNCH
BLACK COOKIE (GLUTEN FREE)**

White chocolate with pieces of biscuit and dark chocolate, in a thin layer of sugar.



**TWO MILK CRUNCH
CRUNCHY CARAMEL (GLUTEN FREE)**

White chocolate with pieces of crispy caramel and milk chocolate, in a thin layer of sugar.



**TWO MILK MIX 1 KG/500g
(GLUTEN FREE)**

Mix of dragees in different tastes: whipped cream, cream and strawberry, cremino, toffee, chocostè, raspberry yoghurt and flan in a thin layer of sugar.



**TWO MILK PANNA E FRAGOLA/
MILK CREAM AND STRAWBERRY (GLUTEN FREE)**

White chocolate in white cream and strawberry flavored chocolate dragees.



**TWO MILK BURRO D'ARACHIDI/
PEANUTS BUTTER (GLUTEN FREE)**

An inner layer of white chocolate in milk peanuts butter flavoured chocolate, in a thin layer of sugar



**TWO MILK BIANCO-ARANCIO/
ORANGE (GLUTEN FREE)**

White chocolate in white orange flavored chocolate dragees.



**TWO MILK CHOCOSTÈ/
BISCUIT CHOCOSTÈ (GLUTEN FREE)**

Dark chocolate in milk gianduja chocolate dragees.

TWO MILK

1Kg pack



**TWO MILK CREMA CHANTILLY E FRAGOLINE/
CREAM AND FORREST STRAWBERRY (GLUTEN FREE)**
*White chocolate in white chatilly cream and strawberries
flavored chocolate dragees.*



**TWO MILK PANNA COTTA/
MILK CREAM BAKED (GLUTEN FREE)**
*White chocolate in white panna cotta flavored
chocolate dragees.*



**TWO MILK EXTRACOK/
DARK AND WHITE CHOCOLATE (GLUTEN FREE)**
Dark and White chocolate in a thin layer of sugar



**TWO MILK FIOR DI LATTE/
MILK SUPREME (GLUTEN FREE)**
*White chocolate in white fior di latte flavored
chocolate dragees.*



**TWO MILK BACIO/
HAZELNUT AND CHOCOLATE (GLUTEN FREE)**
White chocolate in milk bacio flavored chocolate dragees.



**TWO MILK YOGURT E LAMPONI/
YOGURT AND RASPBERRY (GLUTEN FREE)**
*White Chocolate in white yogurt berries flavored
chocolate dragees.*



**TWO MILK LATTE MOU/
CANDY MOU (GLUTEN FREE)**
*White chocolate in white milk and mou flavored
chocolate dragees.*



**TWO MILK VANIGLIA/
VANILLA (GLUTEN FREE)**
*White Chocolate in white vanilla flavored
chocolate dragees.*



**TWO MILK LATTE E MENTA/
MILK AND MINT (GLUTEN FREE)**
*White chocolate in white milk and mint flavored
chocolate dragees.*



**TWO MILK LIMONCELLO/
LIMONCELLO (GLUTEN FREE)**
*White Chocolate in white lemon flavored
chocolate dragees.*

TWO MILK

1Kg pack



**TWO MILK CREMINO/
MILK AND DARK CHOCOLATE (GLUTEN FREE)**

An inner layer of white chocolate in milk and dark chocolate, in a thin layer sugar.



**TWO MILK CIOCCOLATO BIANCO/
WHITE CHOCOLATE (GLUTEN FREE)**

An inner layer of white chocolate in a thin layer sugar.



**TWO MILK FLAN/
CHOCOLATE FLAN (GLUTEN FREE)**

Dark flan cake flavored chocolate dragees.

EASTER

Multi pack



OVETTE NOCCIOMAX 700g

Toasted hazelnut covered with hazelnut cream and milk chocolate in a thin layer of sugar.

Available Colours



COLORED



MARBLED



CHOCOLATE EGGS 150g

Ovette with dark and milk chocolate filled with assorted flavors cream and covered with a thin layer of sugar



OVETTE CREAM 150g

Ovette with dark and milk chocolate filled with assorted flavors cream and covered with a thin layer of sugar



OVETTE CREAM BAG 1Kg

(SINGLE WRAPPED)
Ovette with dark and milk chocolate filled with assorted flavors cream and covered with a thin layer of sugar

EASTER

Multi pack



OVETTE CREAM 500g/1Kg

Ovette with dark and milk chocolate filled with assorted flavors cream and covered with a thin layer of sugar.

Your color, your taste



FONDATE



LATTE



BIANCO



GIANDUIA



PISTACCHIO



TRAPEZIO OVETTE CREAM 180g (SINGLE WRAPPED)

Ovette with dark and milk chocolate filled with assorted flavors cream and covered with a thin layer of sugar.



EXPO BOCCA DI LUPO OVETTE CREAM 1.500g (SINGLE WRAPPED)

Ovette with dark and milk chocolate filled with assorted flavors cream and covered with a thin layer of sugar.



CADEAUX OVETTE CREAM 500g (SINGLE WRAPPED)

Ovette with dark and milk chocolate filled with assorted flavors cream and covered with a thin layer of sugar.

Your color, your taste



DARK

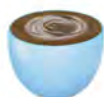

MILK



WHITE



GIANDUIA CREAM



PISTACHE CREAM



CHOCOLATE EGGS 1Kg

Chocolate Eggs with milk chocolate filled with hazelnut cream and covered with a thin layer of sugar.

Available Colours



COLORED



MARbled

EASTER

Multi pack



VASO UOVA DI GALLINA CONFETTATE 40 PCS/60 PCS
Chocolate eggs, hen size, covered with a layer of colored sugar.



UOVA DI GALLINA CONFETTATE 6 PCS
Chocolate eggs, hen size, covered with a layer of colored sugar.



OVETTE CREAM MIX: Dark - Milk - White - Gianduia Cream - Pistachio Cream



NOCCIOMAX: Mix - Marbled



OVETTE CONFETTATE AL LATTE: Mix - Marbled



NUANCIER DES DRAGÉES



BLANC



BEIGE CLAIR - 7500



BEIGE - 7502



JAUNE SOLEIL - 109



SAUMON - 1565



ORANGE - 1495



ROUGE - 1795



FUCHSIA - 220



BORDEAUX - 1807



MARRON - 4635



BRUN - 490



LAVANDE - 7654



LILAS - 530



ROSE - 217



PARME - 2635



BLEU - 290



BLEU BÉBÉ - 310



TURQUOISE - 312



BLEU ROI - 285



INDIGO - 660



BLEU MARINE - 7701



JAUNE ACIDE - 3955



VERT ACIDE - 374



PISTACHE - 353



TIFFANY - 3255



VERT - 354



VERT BOUTEILLE - 349



GRIS CLAIR - COOL GREY 7



GRIS FONCÉ - COOL GREY 11



NOIR - BLACK 6



ARGENT - ARGENTO A CALDO



OR - ORO A CALDO

LES COULEURS SONT INDICATIVES ET SUJETTES AUX VARIATIONS POUVANT SURVENIR PENDANT LA PHASE DE PRODUCTION QUI RESTE, JUSQU'À CE JOUR, RÉALISÉE SELON LA MÉTHODE TRADITIONNELLE.

COLOR GUIDE

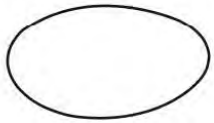

WHITE



IVORY - 7500



BEIGE - 7502



YELLOW - 109



SALMON - 1565



ORANGE - 1495



RED - 1795



FUCHSIA - 220



RED BURGUNDY - 1807



BROWN - 4635



DARK BROWN - 490



LAVANDER - 7654



LILAC - 530



PINK - 217



DARK LILAC - 2635



SKY BLUE - 290



LIGHT BLUE - 310



TURQUOISE - 312



BLUE - 285



INDIGO - 660



BLEU MARINE - 7701



ACID YELLOW - 3955



ACID GREEN - 374



PISTACHE - 353



TIFFANY - 3255



GREEN - 354



GREEN BOTTLE - 349



LIGHT GREY - COOL GREY 7



DARK GREY - COOL GREY 11



BLACK - BLACK 6



SILVER - ARGENTO A CALDO



GOLD - ORO A CALDO

THE COLOURS CAN GO THROUGH VARIATIONS DURING THE PRODUCTION, WHICH AS OF TODAY, HAS BEEN CARRIED OUT FOLLOWING A TRADITIONAL METHOD.

REALTÀ ITALIANE

*La Italiana Confetti da sempre
crede nelle collaborazioni tra aziende di eccellenza,
da qui l'accordo con le imprese leader dei propri settori,
il tutto Made in Italy.*

Confetti
maxtris[®]
insieme a



Bellezza da assaporare.
Creatori di cioccolato e di piaceri.
Inventori del gianduotto.
La cultura torinese del
cioccolato.

KIMBO[®]

Per i cultori del caffè
L'unicità e la tradizione
dell'espresso napoletano.
Il piacere di fare un caffè per tutti
ma non da tutti.



Rinascimento enologico del Meridione.
Passione e innovazione,
riscoprendo il territorio e prestando
attenzione al nuovo mondo
globalizzato, con tradizione e successo
commerciale.



Esempio di "modello industriale" tradizionale.
Il segreto del successo di Strega
Alberti risiede nella capacità di
conciliare l'abilità artigiana al
progresso tecnologico.



Prodotto e distribuito da
Italiana Confetti s.r.l.

*Confetti
maxtris*

Sede: Via Monte, 6 – SOMMA VESUVIANA (NA)
Stabilimento: Via Cerqua S. Antonio s.n.c. Zona Industriale
80030 – SCISCIANO (NA)
Tel. 081 844 28 99 – Tel/Fax 081 844 23 66
exportprisco@gmail.com





maxtris[®]

— CIOCCOLATO —

CATALOGO 2021

Vesuviotto®
maxtris

Il cioccolatino **Made in Napoli**





Vesuviotto Maxtris / Confezione da 160 g



Vesuviotto Maxtris Classico Cornet 160 g

Ciocolatino con guscio al cioccolato al latte e morbido ripieno di crema al latte, gianduia e granella di nocciole Giffoni tostate.

Milk chocolate filled with milk and gianduia cream and grains toasted Giffoni hazelnuts.

COD. U.V. CRT: VMCL1A160
EAN CRT: 8022470254495
EAN PZ: 8022470254501



Vesuviotto Maxtris Fondente 70% - Cornet 160 g

Ciocolatino con guscio al cioccolato extra-fondente e morbido ripieno di crema fondente.

Extra dark chocolate filled with dark cream.

COD. U.V. CRT: VMCF70160
EAN CRT: 8022470254518
EAN PZ: 8022470254525



Vesuviotto Maxtris Limone Cornet 160 g

Ciocolatino con guscio al cioccolato bianco e morbido ripieno di crema bianca al gusto di limoni.

White chocolate filled with lemon flavored cream.

COD. U.V. CRT: VMCL1M160
EAN CRT: 8022470254532
EAN PZ: 8022470254549



Vesuviotto Maxtris Albicocca del Vesuvio - Cornet 160 g

Ciocolatino con guscio al cioccolato fondente e morbido ripieno di crema bianca al gusto di albicocca.

Dark chocolate filled with white cream apricots flavored.

COD. U.V. CRT: VMCALB160
EAN CRT: 8022470254556
EAN PZ: 8022470254563

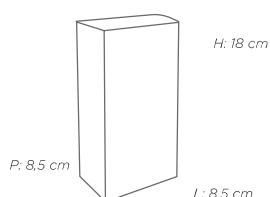

SCHEDA TECNICA PER SUPPORTO VENDITA

PESO PZ.: 160 g
PZ. PER CRT.: 12
DIMENSIONI CRT.: L 39.5 cm x H 22 cm x P 26.5 cm

CARTONI X STRATO STRATI X PALLET H.PALLET

9 7 144 cm



Vesuviotto Maxtris / Confezione da 500 g



Vesuviotto Maxtris Classico Bag 500 g

Ciocolatino con guscio al cioccolato al latte e morbido ripieno di crema al latte, gianduia e granella di nocciole Giffoni tostate.

Milk chocolate filled with milk and gianduia cream and grains toasted Giffoni hazelnuts.

COD. U.V. CRT: VMBCLA500
EAN CRT: 8022470254570
EAN PZ: 8022470254587



Vesuviotto Maxtris Fondente 70% Bag 500g

Ciocolatino con guscio al cioccolato extra-fondente e morbido ripieno di crema fondente.

Extra dark chocolate filled with dark cream.

COD. U.V. CRT: VMBF70500
EAN CRT: 8022470254594
EAN PZ: 8022470254600



Vesuviotto Maxtris Limone Bag 500 g

Ciocolatino con guscio al cioccolato bianco e morbido ripieno di crema bianca al gusto di limoni.

White chocolate filled with lemon flavored cream.

COD. U.V. CRT: VMBLIM500
EAN CRT: 8022470254617
EAN PZ: 8022470254624



Vesuviotto Maxtris Albicocca del Vesuvio - Bag 500 g

Ciocolatino con guscio al cioccolato fondente e morbido ripieno di crema bianca al gusto di albicocca.

Dark chocolate filled with white cream apricot flavored.

COD. U.V. CRT: VMBALB500
EAN CRT: 8022470254631
EAN PZ: 8022470254648

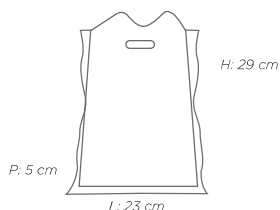

SCHEDA TECNICA PER SUPPORTO VENDITA

PESO PZ.: 500 g
PZ. PER CRT.: 8
DIMENSIONI CRT.: L 39,5 cm x H 22 cm x P 26,5 cm

CARTONI X STRATO	STRATI X PALLET	H.PALLET
9	7	144 cm



Vesuviotto Maxtris / Confezione da 1 Kg, 400g e 220g

Vesuviotto Maxtris Classico Sfuso 1 Kg

COD. U.V. CRT: VMSCLA
EAN CRT: 8022470254655
EAN PZ: 8022470254662

Vesuviotto Maxtris Fondente 70% Sfuso 1 Kg

COD. U.V. CRT: VMSF70
EAN CRT: 8022470254679
EAN PZ: 8022470254686

Vesuviotto Maxtris Limone della Costiera – Sfuso 1 Kg

COD. U.V. CRT: VMSLIM
EAN CRT: 8022470254693
EAN PZ: 8022470254709

Vesuviotto Maxtris Albicocca del Vesuvio – Sfuso 1 Kg

COD. U.V. CRT: VMSALB
EAN CRT: 8022470254716
EAN PZ: 8022470254723



Vesuviotto Maxtris Regal Mix – 400 g

Confezione da 400g con Vesuviotto ai gusti assortiti.

400g packs with mixed taste Vesuviotto.

COD. U.V. CRT: VMRMIX400
EAN PZ: 8022470254785

Vesuviotto Maxtris Sfuso 1 Kg

Confezione da 1 Kg con etichetta

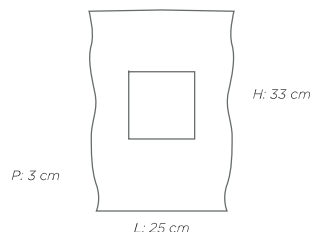

SCHEDA TECNICA PER SUPPORTO VENDITA

PESO PZ: 1 Kg
PZ. PER CRT: 4
DIMENSIONI CRT: L 39,5 cm x H 22 cm x P 26,5 cm

CARTONI X STRATO	STRATI X PALLET	H.PALLET
9	7	144 cm 



Vesuviotto Maxtris Classico Cilindro – 220 g

Confezione in latta da 220g con Vesuviotto Classico.

220 g tin package with Classic Vesuviotto.

COD. U.V. CRT: VMCIL220
EAN PZ: 8022470254792

Vesuviotto Maxtris / Confezione da 100 g



Vesuviotto Maxtris Classico - Gift 100 g

Ciocolatino con guscio al cioccolato al latte e morbido ripieno di crema al latte, gianduia e granella di nocciole Giffoni tostate.

Milk chocolate filled with milk and gianduia cream and grains toasted Giffoni hazelnuts.

COD. U.V. CRT: VMGCLA100
EAN PZ: 8022470254747



Vesuviotto Maxtris Fondente 70% - Gift 100 g

Ciocolatino con guscio al cioccolato extra-fondente e morbido ripieno di crema fondente.

Extra dark chocolate filled with dark cream.

COD. U.V. CRT: VMGF70100
EAN PZ: 8022470254754



Vesuviotto Maxtris Limone Gift 100 g

Ciocolatino con guscio al cioccolato bianco e morbido ripieno di crema bianca al gusto di limoni.

White chocolate filled with lemon flavored cream.

COD. U.V. CRT: VMGLI100
EAN PZ: 8022470254761



Vesuviotto Maxtris Albicocca del Vesuvio - Gift 100 g

Ciocolatino con guscio al cioccolato fondente e morbido ripieno di crema bianca al gusto di albicocca.

Dark chocolate filled with white cream apricots flavored.

COD. U.V. CRT: VMGALB100
EAN PZ: 8022470254778

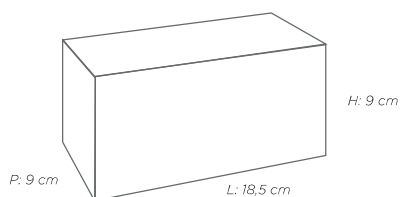

SCHEDA TECNICA PER SUPPORTO VENDITA

PESO PZ.: 100 g
DIMENSIONI CRT.: L 39,5 cm x H 22 cm x P 26,5 cm

CARTONI X STRATO	STRATI X PALLET	H.PALLET
9	7	144 cm





Espositore Vesuviotto Maxtris Cornet
60 pz

Espositore da terra di Vesuviotto Maxtris in confezione cornet, da 60 pezzi.

Floorstand of Vesuviotto Maxtris in cornet pack, 60 pieces.

COD. U.V.: VMCESP160
EAN: 8022470254808

MOON



Gluten free

Maxtris Moon / Confezione da 165 g



Maxtris Moon Latte Stabilo 165 g

Boule con guscio al cioccolato al latte e ripieno con crema al latte.

Ball with milk chocolate filled with a milk chocolate cream.

COD. U.V. CRT: MMSLAT165
EAN CRT: 8022470254822
EAN PZ: 8022470254815



Maxtris Moon Pistacchio Stabilo 165 g

Boule con guscio al cioccolato al latte e ripieno con crema bianca al gusto pistacchio.

Ball with milk chocolate filled with white cream pistachio flavored.

COD. U.V. CRT: MMSPI165
EAN CRT: 8022470254853
EAN PZ: 8022470254877



Moon Fondente 70% Stabilo 165 g

Boule con guscio al cioccolato extra fondente al 70% e morbido ripieno di crema fondente.

Ball with a shell of extra dark chocolate and filled with an extra dark chocolate cream.

COD. U.V. CRT: MMSF70165
EAN CRT: 8022470254846
EAN PZ: 8022470254839



Moon Nocciolato Stabilo 165 g

Boule con guscio al cioccolato fondente e morbido ripieno di crema al latte gianduia con nocciole intere 100% italiane.

Ball with dark chocolate filled with dark chocolate cream and whole 100% italian hazelnut.

COD. U.V. CRT: MMSNOC165
EAN CRT: 8022470254860
EAN PZ: 8022470254884

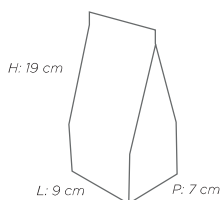

SCHEDA TECNICA PER SUPPORTO VENDITA

PESO PZ: 165 g
PZ. PER CRT: 15
DIMENSIONI CRT: L 39,5 cm x H 22 cm x P 26,5 cm

CARTONI X STRATO	STRATI X PALLET	H.PALLET
9	7	144 cm 

Maxtris Moon / Confezione da 500 g



Maxtris Moon Latte – Bag 500 g

Boule con guscio al cioccolato al latte e ripieno con crema al latte.

Ball with milk chocolate filled with a milk chocolate cream.

COD. U.V. CRT: MMBLAT500
EAN CRT: 8022470254938
EAN PZ: 8022470254891



Maxtris Moon Pistacchio – Bag 500 g

Boule con guscio al cioccolato al latte e ripieno con crema bianca al gusto pistacchio.

Ball with milk chocolate filled with white cream pistachio flavored.

COD. U.V. CRT: MMBPIS500
EAN CRT: 8022470254952
EAN PZ: 8022470254914



Maxtris Moon Fondente 70% (cacao min) – Bag 500 g

Boule con guscio al cioccolato extra fondente al 70% e morbido ripieno di crema fondente.

Ball with a shell of extra dark chocolate and filled with an extra dark chocolate cream.

COD. U.V. CRT: MMBF70500
EAN CRT: 8022470254945
EAN PZ: 8022470254907



Maxtris Moon Nocciolato Bag 500 g

Boule con guscio al cioccolato fondente e morbido ripieno di crema al latte gianduia con nocciole intere 100% italiane.

Ball with dark chocolate filled with dark chocolate cream and whole 100% Italian hazelnut.

COD. U.V. CRT: MMBNOC500
EAN CRT: 8022470254969
EAN PZ: 8022470254921

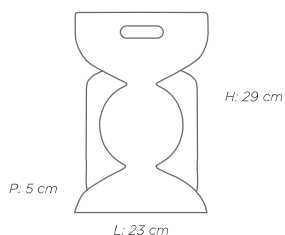

SCHEDA TECNICA PER SUPPORTO VENDITA

PESO PZ: 500 g
PZ. PER CRT: 8
DIMENSIONI CRT: L 39,5 cm x H 22 cm x P 26,5 cm

CARTONI X STRATO	STRATI X PALLET	H.PALLET
9	7	144 cm



Maxtris Moon / Espositore

Maxtris Moon Latte Sfuso 1 Kg

COD. U.V. CRT: *MMSLAT*
EAN CRT: 8022470255010
EAN PZ: 8022470254976

Maxtris Moon Pistacchio Sfuso 1 Kg

COD. U.V. CRT: *MMSPI5*
EAN CRT: 8022470255034
EAN PZ: 8022470254990

Maxtris Moon 70% Fondente Sfuso 1 Kg

COD. U.V. CRT: *MMSF70*
EAN CRT: 8022470255027
EAN PZ: 8022470254983

Maxtris Moon Nocciolato Sfuso 1 Kg

COD. U.V. CRT: *MMSNOC*
EAN CRT: 8022470255041
EAN PZ: 8022470255003

Maxtris Moon Sfuso 1 Kg

Confezione da 1 Kg con etichetta

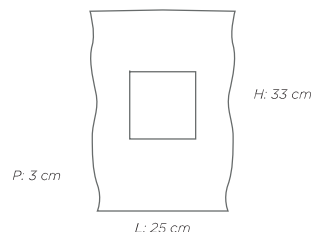

SCHEDA TECNICA PER SUPPORTO VENDITA

PESO PZ: 1 Kg
PZ. PER CRT: 4
DIMENSIONI CRT: L 39,5 cm x H 22 cm x P 26,5 cm

CARTONI X STRATO	STRATI X PALLET	H.PALLET
9	7	144 cm



Espositore Vesuviotto Maxtris Cornet 80 pz

Espositore da terra di Maxtris Moon in confezione stablopack, da 60 pezzi.

Floorstand of Maxtris Moon in stablopack, 80 pieces.

COD. U.V.: *MMSESP165*
EAN: 8022470255058



Maxtris TAB / Tavolette da 100 g



Maxtris TAB Latte Tavoletta 100 g

Tavoletta con finissimo cioccolato al latte.

Fine milk chocolate bar.

COD. U.V. CRT: TMLAT100
EAN CRT: 8022470255065
EAN PZ: 8022470255140



Maxtris TAB Nocciolato Latte - Tavoletta 100 g

Tavoletta con Cioccolato al latte e nocchie intere 100% italiane.

Milk chocolate bar with whole 100% italian hazelnut.

COD. U.V. CRT: TMLATNOC100
EAN CRT: 8022470255072
EAN PZ: 8022470255157



Maxtris TAB Mandorlato Bianco - Tavoletta 100 g

Tavoletta con cioccolato bianco e mandorle intere tostate.

White chocolate bar with toasted almonds.

COD. U.V. CRT: TMBIAMAN100
EAN CRT: 8022470255089
EAN PZ: 8022470255164



Maxtris TAB Crunch Tavoletta 100 g

Tavoletta con cioccolato al latte e minilenti al cioccolato.

Milk chocolate bar with chocolate mini-lens.

COD. U.V. CRT: TMCRU100
EAN CRT: 8022470255096
EAN PZ: 8022470255171

Maxtris TAB / Tavolette da 100 g



Maxtris TAB Fondente 70% Tavoletta 100 g

Tavoletta con irresistibile cioccolato extra-fondente.

Irresistible extra-dark chocolate bar.

COD. U.V. CRT: TMF70100
EAN CRT: 8022470255102
EAN PZ: 8022470255188



Maxtris TAB Fondente 85% Tavoletta 100 g

Tavoletta con cioccolato extra-fondente deciso e intenso.

Strong and intense extra dark chocolate bar.

COD. U.V. CRT: TMF85100
EAN CRT: 8022470255119
EAN PZ: 8022470255195



Maxtris TAB Mandorlato Tavoletta 100 g

Tavoletta con cioccolato fondente e mandorle intere tostate.

Extra dark chocolate bar with toasted almonds.

COD. U.V. CRT: TMFMAN100
EAN CRT: 8022470255126
EAN PZ: 8022470255201



Maxtris TAB Nocciolato Fondente – Tavoletta 100 g

Tavoletta con cioccolato fondente e nocciole intere 100% italiane.

Extra-dark chocolate with whole 100% Italian hazelnuts.

COD. U.V. CRT: TMFNOC100
EAN CRT: 8022470255133
EAN PZ: 8022470255218

Maxtris TAB /Espositore

Maxtris TAB 100g

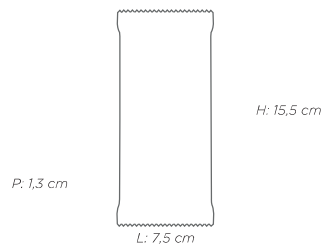

U.V. Maxtris TAB 100g

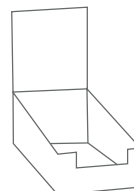

SCHEDA TECNICA PER SUPPORTO VENDITA

PESO PZ.:	100 g
PZ. PER RIC.:	12
PZ. PER CRT.:	12
DIMENSIONI CRT.:	L 39,5 cm x H 22 cm x P 26,5 cm

CARTONI X STRATO	STRATI X PALLET	H.PALLET
9	7	144 cm 



Espositore Maxtris TAB 64 pz

Espositore da banco di Maxtris TAB convertibile da terra di tavolette, da 64 pezzi.

Counter display available also in floorstand mode of Maxtris TAB, 64 pieces.

COD. U.V. CRT: TMESP100
EAN PZ: 8022470255461

Ricariche

Da 12 pezzi.

From 12 pieces.



Calendario dell'Avvento / 288 g



Calendario Dell'Avvento 288 g

Calendario dell'avvento con Cioccolato
Maxtris.

Advent Calendar with Maxtris Chocolate.

COD. U.V. CRT: *SCM288*
EAN PZ: *8022470255478*

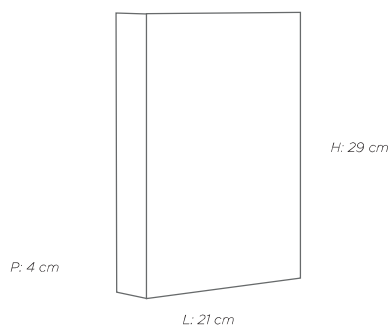

SCHEDA TECNICA PER SUPPORTO VENDITA

PESO PZ:	288 g
PZ. PER CRT:	4
COD. ART: CRT:	CM288
EAN CRT:	8022470255232
DIMENSIONI CRT:	L 30 cm x H 18 cm x P 22 cm

CARTONI X STRATO	STRATI X PALLET	H.PALLET
9	7	144 cm



Calendario Dell'Avvento *Un Natale goloso per grandi e piccini*

*Una preziosa scatola pronta a
trasformarsi nel tuo speciale
portagioie per custodire ciò che ami.*

Truffle Bag / Confezione da 165 g



Truffle Bag Ciliegie Fondente

Ciliegia amarenizzata ricoperta di cioccolato fondente e tartufata con polvere di cacao.

Candied cherry in dark chocolate and dusted with cocoa powder.

COD. U.V. CRT: TRAPCIL165
EAN CRT: 8022470248982
EAN PZ: 8022470246537



Truffle Bag Nocciole Latte

Nocciola tostata ricoperta di cioccolato al latte e tartufata con polvere di cacao.

Toasted hazelnut in milk chocolate and dusted with cocoa powder.

COD. U.V. CRT: TRAPNOCL165
EAN CRT: 8022470249002
EAN PZ: 8022470249927



Truffle Bag Nougat Fondente

Croccantino alla nocciola ricoperto di cioccolato fondente e tartufato con polvere di cacao.

White chocolate bar with toasted almonds.

COD. U.V. CRT: TRAPNOUFI65
EAN CRT: 8022470248975
EAN PZ: 8022470246544



Truffle Bag Mandorle Fondente

Mandorla tostata ricoperta di cioccolato fondente e tartufata con polvere di cacao.

Toasted almond in dark chocolate and dusted in cocoa powder.

COD. U.V. CRT: TRAPMANFI65
EAN CRT: 8022470248999
EAN PZ: 8022470249910

Truffle Bag / Espositore

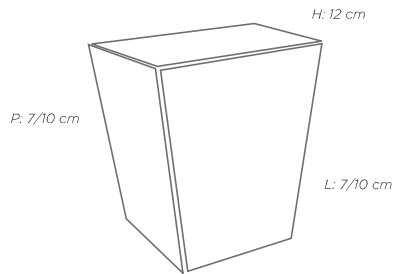

SCHEDA TECNICA PER SUPPORTO VENDITA

PESO PZ.: 165g
PZ. PER CRT.: 8
DIMENSIONI CRT.: L 40 cm x H 18 cm x P 26,5 cm

CARTONI X STRATO	STRATI X PALLET	H.PALLET
9	6	126cm



Espositore

COD. U.V. CRT: TARSP0C0C500
EAN: 8022470227680